

Perk Filter™ Research and Development 2008 - 2009

January 8, 2009

**Prepared for KriStar, Inc.
under contract 515081**

Final Report

Table of Contents

Executive Summary	7
1 Introduction	9
1.1 Background and Purpose	9
1.2 Perk Filter™ Description	9
1.2.1 Filter Media Configuration	10
1.2.2 Inner Tubing Design	10
1.2.3 Naming Convention	11
2 Methodology	12
2.1 Setup	12
2.1.1 Hydraulics Lab at Sacramento State	12
2.1.2 OWP Outdoor Lab at Sacramento State	13
2.2 Sediment Sources and Slurry Preparation	15
2.2.1 Ground Silica (Sil-Co-Sil 106)	15
2.2.2 Street Dust	15
2.2.3 Sediment Comparison	16
2.2.4 Slurry Preparation	17
2.3 Sampling	18
2.4 Analysis	18
3 Preliminary Testing	19
3.1 Protocol	19
3.1.1 Hydraulic Verification	19
3.1.2 Total Suspended Solids Verification	19
3.2 Results	19
3.2.1 Hydraulic Verification	19
3.2.2 Total Suspended Solids Verification	20
4 Long-Term Ground Silica Test	21
4.1 Protocol	21
4.2 Results	22

5 Street Dust Testing for TSS, TN, TP, and Metals	24
5.1 Protocol	24
5.1.1 Scheduled Test	24
5.1.2 Additional Runs	25
5.1.3 Additional Modification and Hydraulic Test	25
5.2 Results	25
5.2.1 Scheduled Test and Additional Runs	26
5.2.2 Regressions of percent removal versus load for TSS, SSC, and turbidity and percent removal versus flow for all constituents	26
5.2.3 Nitrogen Analysis	33
5.2.4 Metals Analysis	33
5.2.5 Analysis of Variation of Regression Analysis	37
5.2.6 Additional Modification and Hydraulic Test	39
6 References	40
APPENDIX A: Calculations	41
APPENDIX B: Laboratory Reports (available on CD)	49

List of Tables

Table 1. Filter Media Configuration and Test Summary	10
Table 2. Perk Filter™ Configuration Naming Convention.	11
Table 3. Summary of analysis performed.	18
Table 4. Sample schedule for the TSS verification test.	19
Table 5. Sample schedule for the long-term ground silica test.	21
Table 6. Sample schedule for Street Dust Test – Runs 1 through 15.	24
Table 7. Sample schedule for Street Dust Test – Runs 16 through 18.	25
Table 8. M2T2 TSS results and statistics.	26
Table 9. M2T2 total phosphorus results and statistics.	30
Table 10. M2P2 orthophosphate results and statistics.	32
Table 11. M2T2 total copper results and statistics.	33
Table 12. M2T2 total aluminum results and statistics.	35
Table 13. M2T2 total zinc results and statistics.	36
Table 14. F ratio and F critical values for each test parameter.	37

List of Figures

Figure ES.1. Performance curves vs. flow.	8
Figure 2. (a) Representation of how a Perk Filter™ would be installed in a typical vault that had adjoining sedimentation pretreatment. (b) A generic Perk Filter™ design.	9
Figure 3. Changes made to the Perk Filter™ during 2009 tests.	10
Figure 4. Generic schematic of the Perk Filter™ installed in a test tank.	12
Figure 5. Test tank setup in hydraulic lab at Sacramento State.	13
Figure 6. Slurry injection setup at the OWP outdoor lab at Sacramento State.	13
Figure 7. Test tank setup for 2009 preliminary tests with M1T1 and M2T2.	14
Figure 8. Test tank setup for the long-term test with M1T2 and the street dust test with M2T2.	14
Figure 9. Process diagram of system.	15
Figure 10. 500 mg/L Street Dust and Ground Silica Comparison: Particle Count vs. Size	16
Figure 11. Mass based PSD comparison of ground silica and street dust	17
Figure 12. M1T1 and M1T2 hydraulic capacity results.	20
Figure 13. M1T2 performance results compared to 2007 Perk Filter™ results at 13.6 gpm.	20
Figure 14. M1T2 long-term TSS, SSC, and turbidity performance results.	22
Figure 15. M1T2 performance results compared to ECY DOE treatment standards.	22
Figure 16 a. M2T2 percent removal vs. instantaneous loading for runs 1 to 3.	27
Figure 16 b. M2T2 percent removal vs. instantaneous loading for runs 3 to 6, and 16.	27
Figure 16 c. M2T2 percent removal vs. instantaneous loading for runs 7 to 9.	28
Figure 16 d. M2T2 percent removal vs. instantaneous loading for runs 10 to 12, 17 and 18.	28
Figure 16 e. M2T2 percent removal vs. instantaneous loading for runs 13 to 15.	29
Figure 16 f. M2T2 TSS, SSC, and turbidity results as load increases.	29
Figure 17. M2T2 TSS results VS. flow, compared to ECY DOE treatment standards.	30

Figure 18. M2T2 total phosphorus results compared to TSS and ECY DOE treatment standards.	31
Figure 19. M2T2 orthophosphate results.	32
Figure 20. M2T2 total copper results.	34
Figure 21. M2P2 total aluminum results.	35
Figure 22. M2P2 total zinc results.	36
Figure 23. M2P2 TSS results by increasing load.	38
Figure 24. (a) M2T2 central tube design with screen. (b) M2T3 central tube design.	39
Figure 25. M2T2 and M2T3 hydraulic capacity results.	39

Executive Summary

A single stack of two 12-inch zeolite-perlite-carbon (ZPC) Perk Filter™ cartridges (filter) were tested with synthetic stormwater made from different sediment sources, depending on the test. A long-term loading test used a manufactured ground silica, Sil-Co-Sil 106, that had 99 percent of the particle mass less than 100 micron in diameter. To estimate field performance, however, street dust was used to assess treatment of total suspended solids, total nitrogen, total phosphorus, total copper, total aluminum, and total zinc (TSS, TN, TP, TCu, TAl, and TZn respectively). Street dust, very fine street sweeping particles less than 75 micron, was used in place of ground silica in this portion of the study to better represent the composition and shape of actual stormwater particles.

After confirming the filter was capable of handling a long-term solids load, it was tested for removing TN, TP, TCu, TAl, and TZn. Nitrogen was not detected in the influent samples so nitrogen analysis was discontinued. Influent concentrations for the other constituents, however, were representative of typical stormwater runoff. Average influent for TP was 0.16 mg/L. The average influent concentrations for metals were 34 µg/L for TCu, 1,600 µg/L for TAl, and 39 µg/L for TZn.

Relative removal among the constituents was as expected. Sediment was removed best, followed by metals, and phosphorus was the most difficult to remove. The measured removal ranged from 31% to 93% for TSS, 17% to 94% for TP, 28% to 68% for TCu, 24% to 84% for TAl, and 13% to 71% for TZn over flows that ranged from 6.8 to 33.7 gpm. Flow had a significant impact on performance as seen in Figure ES.1. Compared to 2007 testing with ground silica, the testing with street dust resulted in higher removal at similar flow rates.

The 2007 ZPC Perk Filter™ was tested with approximately 15.3 kg of SCS and a total volume of 27,000 gallons of water, which is equivalent to treating 4.8 inches of runoff from 0.19 acres using a design intensity of 0.2 in/hr, a 0.9 runoff coefficient, and a design flow of 17 gpm. 4.8 inches of runoff underestimates the annual loading for most climates.

For this project, the long-term loading test with ground silica was performed using 165,600 gallons of water, which is equivalent to treating 29.2 inches of runoff estimated under the above conditions. The filter was loaded with 125 kg of ground silica (at a rate of 200 mg/L TSS), an increase of 110 kg over the previous test. No clogging was observed.

The street dust test used 57,600 gallons of water, which is equivalent to treating 10 inches of runoff under the above conditions. The filter was loaded with a total of 21 kg of street dust at a rate of 100 mg/L TSS. After approximately 17 kg of street dust, the filter showed significant signs of clogging: the water levels increased by 2 to 3 inches per run, and water levels reached 36 inches, which is the height of the test tank. Clogging was found to occur at the screen surrounding the central tube.

The clogging was resolved by removing the central screen and replacing the central tube with a new central tube design. The new central tube was not tested for treatment performance.

Though cumulative loading and other factors may be important in modeling performance (see Section 5.2.2), the simple regressions are provided in Figure ES.1 to estimate the optimum design flow for a stack of two Perk Filter™ cartridges. Maintenance intervals could not be determined because screen and central tube fixes occurred at the end of the study. Thus, longevity, though improved, cannot be quantified.

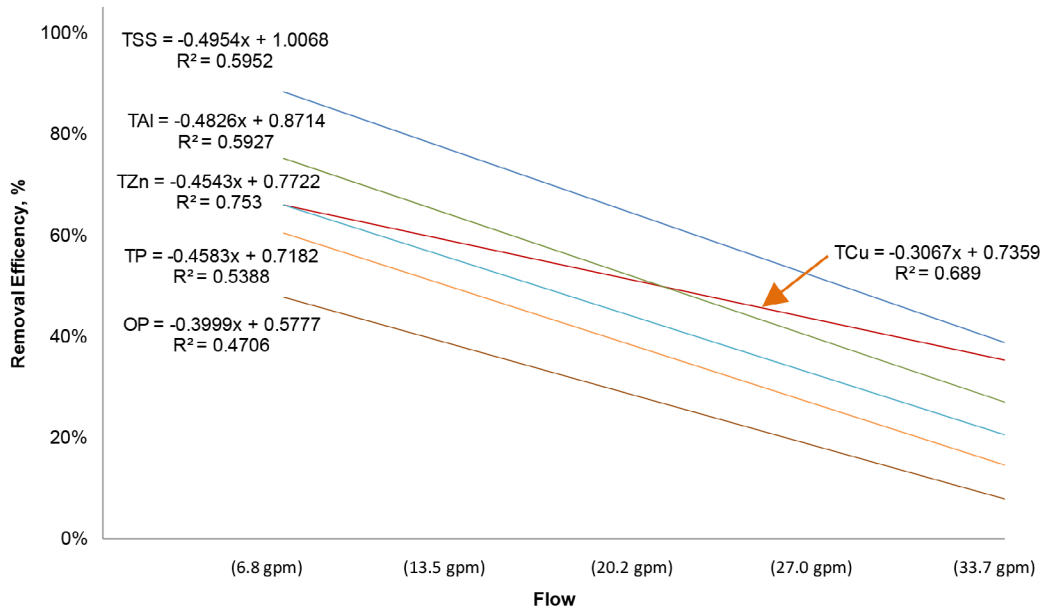

Figure ES.1. Performance curves vs. flow.

1 Introduction

Kristar's Perk Filter™ is a modular media filter intended to remove a wide array of pollutants of concern from stormwater runoff. This filter was tested by the Office of Water Programs (OWP) under contract 515081.

1.1 Background and Purpose

The previous Perk Filter™ Final Report (OWP, 2007) reported that Zeolite-PerliteCarbon (ZPC) had performed better than scoria and a Zeolite-Carbon (ZC) media. The final report states that for influent concentrations below 100 mg/L, 17 gpm may be an appropriate design flow for ZPC to meet the “basic treatment” performance criteria as defined in Washington State regulations (OWP, 2007).

The 2007 ZPC Perk Filter™ was tested with approximately 15.3 kg of ground silica, SilCo-Sil 106 (SCS106), and a total volume of 27,000 gallons of water, which is equivalent to treating 4.8 inches of storm runoff. The equivalent storm runoff depth for a typical catchment can be calculated from 0.19 acres using a design intensity of 0.2 in/hr, a 0.9 runoff coefficient, and a design flow of 17 gpm. 4.8 inches of runoff underestimates the annual loading for most climates. To better anticipate maintenance issues during a typical wet season, a long-term loading test was performed under the current contract.

A disadvantage of this long-term test and all previous Perk Filter™ laboratory tests is the use of ground silica to represent stormwater particles. Although ground silica is very useful in providing consistency among laboratory test methods, it does not represent the composition and shape of actual stormwater particles. Further, other constituents of interest must be artificially introduced to ground silica. Street dust, a superior alternative to ground silica, already has adequate levels of many other constituents because street dust particles are likely to be the very particles that become entrained in stormwater runoff from paved surfaces. Consequently, street dust was used to estimate the field performance of the Perk Filter™.

1.2 Perk Filter™ Description

During the development of the Perk Filter™, numerous design changes were made based on the results of field testing. Changes include using well-mixed versus partitioned media, and altering the inner tubing, consisting of a central tube and a type “P” control tube as shown in figure 2. These changes are discussed in Section 1.2.1 and Section 1.2.2. The generic installation and design of the Perk Filter™ is also shown in Figure 2 below.

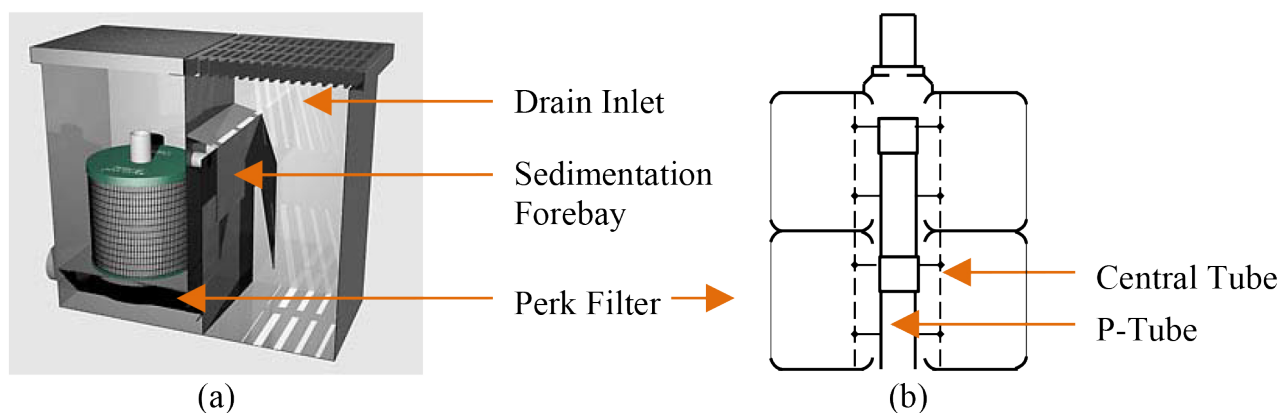



Figure 2. (a) Representation of how a Perk Filter™ would be installed in a typical vault that had adjoining sedimentation pretreatment. (b) A generic Perk Filter™ design.

1.2.1 Filter Media Configuration

For ease of fabrication, the partitioning screen, shown in Table 1, was removed from the 2007 Perk Filter™ design and the media was well-mixed for preliminary and long-term testing. The media configuration reverted back to the partitioned configuration for further testing with street dust because it performed significantly better than the wellmixed media. Table 1 shows the different filter media configurations for each test discussed within this report.

Table 1. Filter Media Configuration and Test Summary

Media	Test	Photo
Zeolite(45%)/perlite(50%)/carbon(5%), 4x8 mesh	2009 Preliminary Tests 2009 Long-term Ground Silica Test	
Outer Shell: 4x30 mesh perlite Inner Shell: 4x8 mesh zeolite/granular activated carbon blend (90%/10% by volume)	2007 Perk Filter Tests 2009 Street Dust Test	

1.2.2 Inner Tubing Design

Changes were made to the inner tubing design midway through the 2009 preliminary tests due to undesired flow restrictions along the P-tube between the two cartridges (see Section 3). Figure 3 shows the changes made.

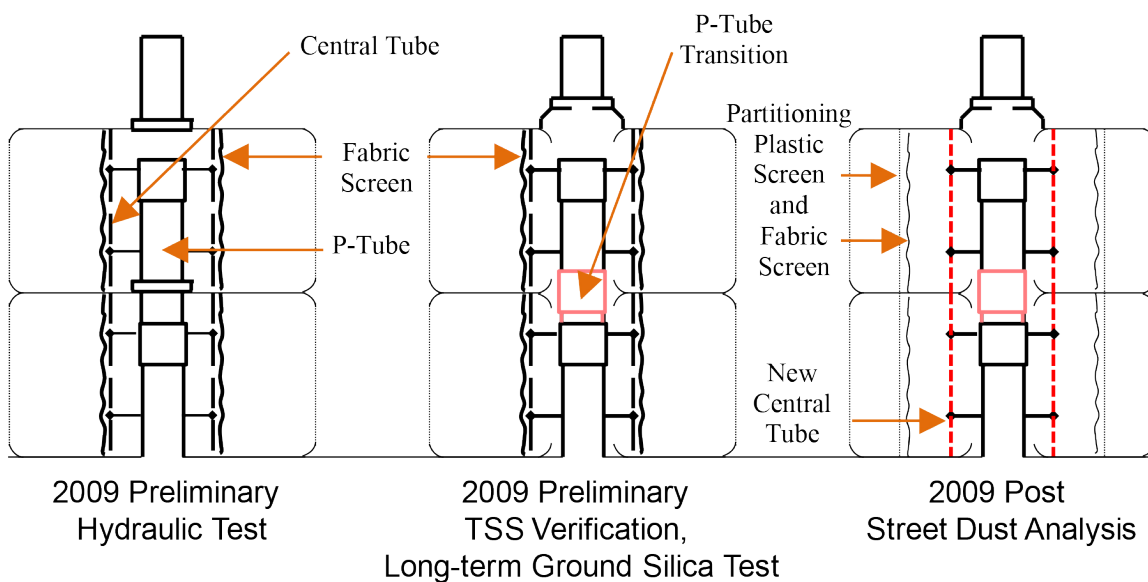

Figure 3. Changes made to the Perk Filter™ during 2009 tests.

1.2.3 Naming Convention

To aid the discussion of differing Perk Filter™ configurations, a naming convention has been established for each configuration tested in 2009. See Table 2.

Table 2. Perk Filter™ Configuration Naming Convention.

2009 Perk Filter™ Test	Name	Filter Media Configuration	Central Tube and P-Tube Hydraulics
1 st Hydraulic Capacity Test	M1T1	Well-mixed	Flow through top filter only
2nd Hydraulic Capacity Test, TSS Verification, Long-term Ground Silica Test	M1T2	Well-mixed	Flow through top & bottom filter
Street Dust Test	M2T2	Partitioned	Flow through top & bottom filter
Post Analysis – Hydraulic Capacity Test	M2T3	Partitioned	Flow through top & bottom filter, no central screen, and new slotted central tube design

2 Methodology

2.1 Setup

For hydraulic testing, the Perk Filter™ was installed in a 23 x 23.5 inch tank that was 30 inches tall. For treatment tests, the Perk Filter™ was installed in a 23.5 inch x 23.5 inch tank that was 36 inches tall. For both tanks, the centerline of the influent manifold was located 16 inches above the invert of the tanks. A generic schematic of the setup is shown in Figure 4. The deeper tank allowed a higher head to develop in anticipation of a decrease in the filter's hydraulic capacity as sediment loading increased throughout the testing.

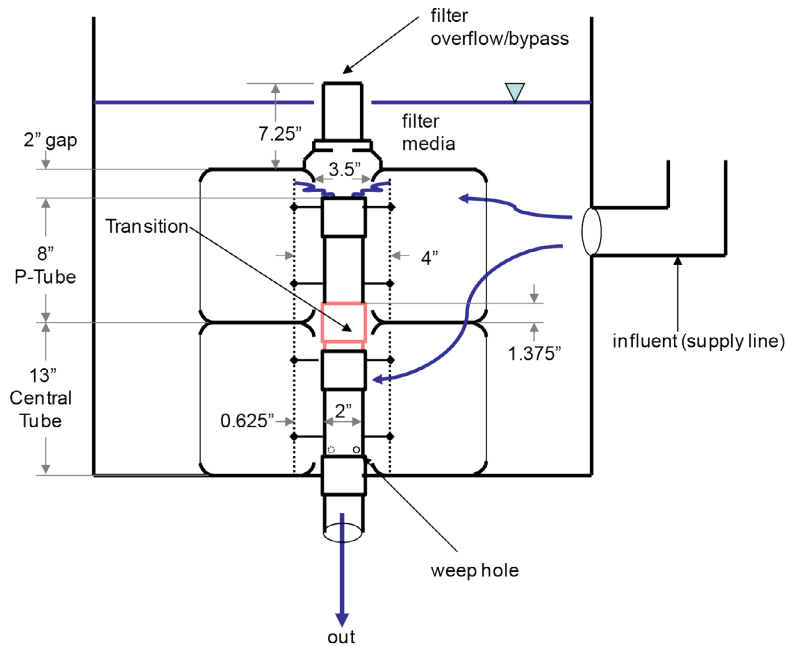

Figure 4. Generic schematic of the Perk Filter™ installed in a test tank.

The setup in the hydraulics lab and the OWP outdoor laboratory at Sacramento State is described herein.

2.1.1 Hydraulics Lab at Sacramento State

The first stage of preliminary testing, hydraulic verification, was performed in the hydraulics lab at Sacramento State because this site has a higher flow capacity than the OWP outdoor laboratory. Flow was measured using a paddle-wheel flow meter. Water was fed to the Perk Filter™ through an influent manifold. Water discharged through a pipe at the bottom of the tank that was adapted to connect to the P-tube of the bottom Perk Filter™. Figure 5 shows the test tank, influent manifold, and the outflow pipe in the hydraulics lab. The fabric shown on the outlet is to prevent fines from flushing from the media into the recirculated water supply.



Figure 5. Test tank setup in hydraulic lab at Sacramento State.

2.1.2 OWP Outdoor Lab at Sacramento State

Treatment tests were performed at the OWP outdoor laboratory at Sacramento State. The setup is similar to the setup in the hydraulics lab except a sediment slurry is injected into the main water supply. The slurry, described further in Section 2.2, is maintained in a mixing tank, and dosed through a peristaltic pump into the main water supply as shown in Figure 6. After injection of slurry, the influent water passes through an inline static mixer that mixes the slurry with the supply water and dampens the pulsation of sediment caused by the peristaltic pump.

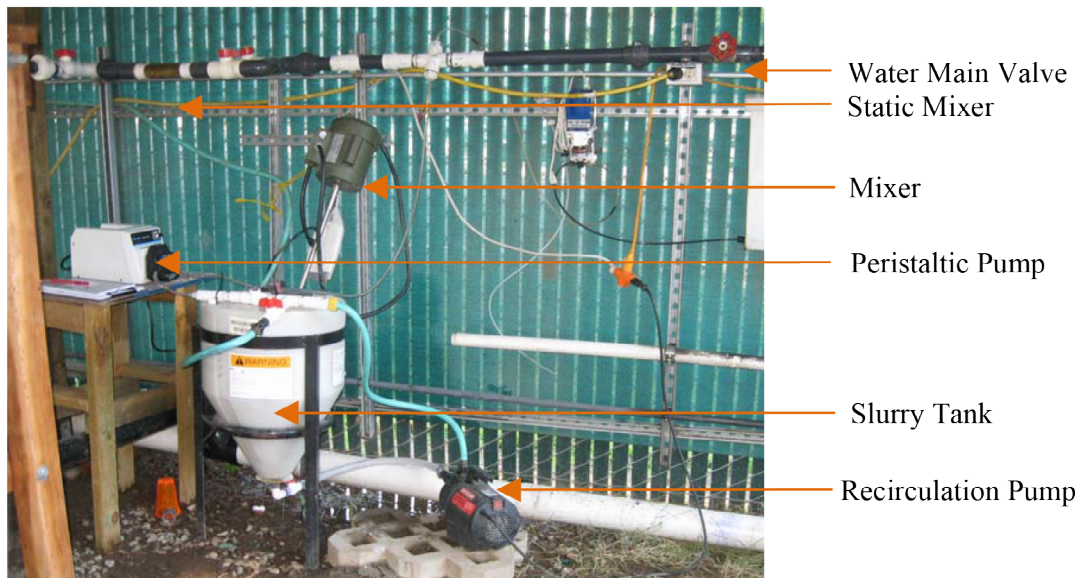

Figure 6. Slurry injection setup at the OWP outdoor lab at Sacramento State.

The locations where influent and effluent grab samples were selected changed during 2009 tests. Influent and effluent samples for the 2009 preliminary tests were taken from the valves specified in Figure 7.

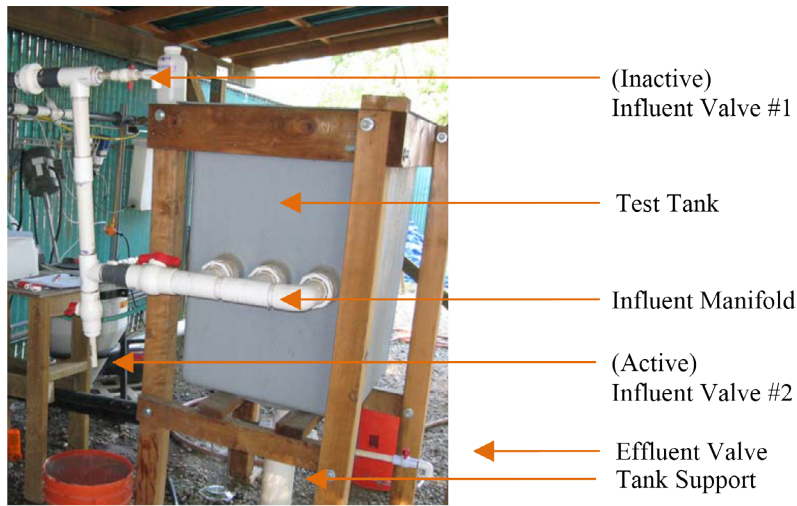

Figure 7. Test tank setup for 2009 preliminary tests with M1T1 and M2T2.

After the preliminary tests, influent was taken from the influent valve and effluent from below the tank as shown in Figure 8. This improvement eliminated dead zones within the pipe.

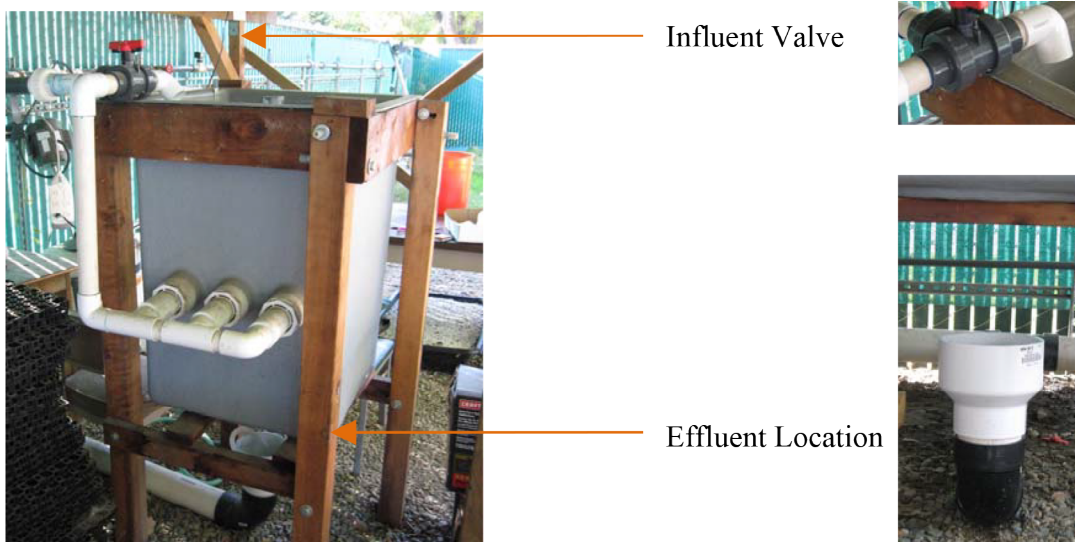

Figure 8. Test tank setup for the long-term test with M1T2 and the street dust test with M2T2.

A process diagram is shown in Figure 9.

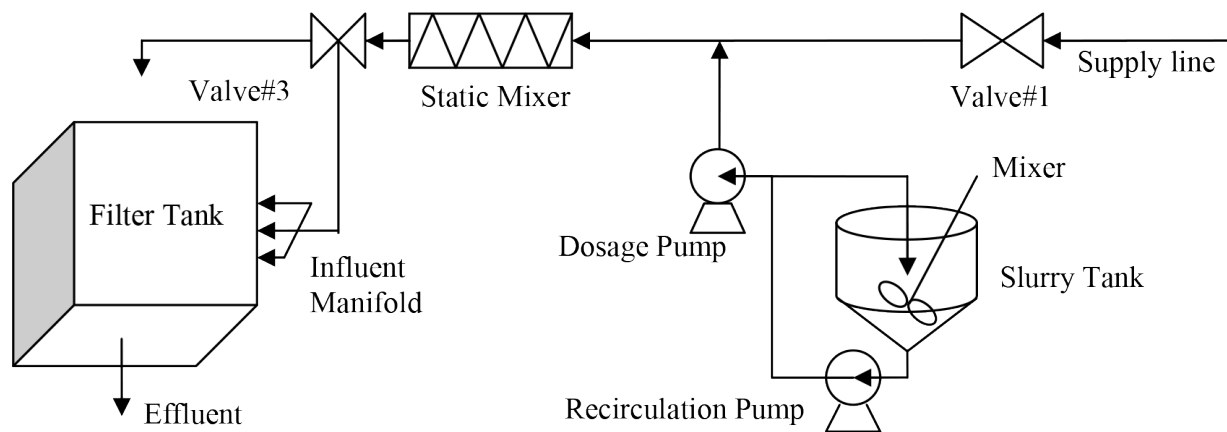

Figure 9. Process diagram of system.

2.2 Sediment Sources and Slurry Preparation

Two types of sediment sources were used: ground silica and street dust. Ground silica was used to test the filters for the preliminary and the long-term test. Street dust was used to better mimic actual sources of TSS, nutrients, and metals.

2.2.1 Ground Silica (Sil-Co-Sil 106)

The ground silica used was Sil-Co-Sil 106 (SCS 106). SCS 106 is white ground sand with a specific gravity of 2.65. One hundred percent of SCS 106 typically passes a #70 US sieve (< 0.212 mm) and 99 percent of SCS 106 passes a #100 US sieve (< 0.100 mm).

2.2.2 Street Dust

The street dust used was the particles collected by street sweepings that passed a #200 US sieve (< 0.075 mm). The target phosphorus content in the street dust was 0.002 g/g based on monitoring from a watershed in the Pacific Northwest where the Perk Filter™ might be used. This ratio was calculated from runoff concentrations of 0.2 mg/L total phosphorus at 120 mg/L TSS. Street sweepings were originally collected from Sacramento County; however, the phosphorus levels were only around 0.0007 g/g. Instead of amending the street sweepings with lawn fertilizer, the street dust was augmented by sweepings from the City of Placerville, City of South Lake Tahoe, and a highway in Pollock Pines where ratios of phosphorus to solids was higher. The composite street dust from Sacramento County, City of Placerville, City of South Lake Tahoe, and a highway in Pollock Pines had an estimated phosphorus content of 0.0009 g/g. See Appendix A for individual values.

To roughly estimate the vegetative content of street dust, volatile solids tests were performed on street dust. Street dust was 10 percent volatile, which indicates a fairly low vegetation component. This also means the specific gravity of most particles could be fairly high, even to the point of not being substantially less than ground silica.

To test this theory, the specific gravity was estimated by putting a known mass of street dust and a known volume of water and dispersing agent into a graduated cylinder. The total volume was subtracted from the volume of water and dispersing agent to determine the volume of the street dust. The mass of the street

dust was then divided by the volume. The calculated specific gravity was found to be about 2, which can be thought of as a rough estimate of average particle density, since the composition of particles in street dust is heterogeneous. See Appendix A for calculations.

2.2.3 Sediment Comparison

Further analysis was performed on ground silica and street dust to compare the two sediments. The analysis included particle size distribution (PSD) by count, PSD by hydrometer testing, and particle image.

Particle Count by Particle Size

A Fluid Particle Image Analyzer (FPIA) was used to perform a particle size distribution test on a 500 mg/L sample of ground silica and a 500 mg/L sample of street dust. Particle count vs. particle size, displayed in Figure 10, shows that ground silica particles are smaller than street dust particles.

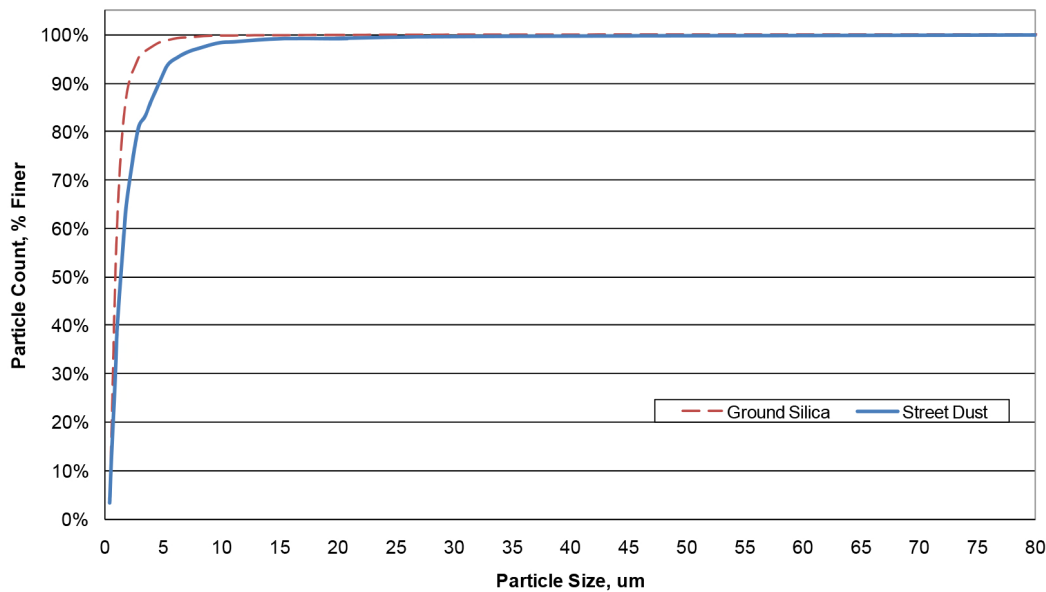

Figure 10. 500 mg/L Street Dust and Ground Silica Comparison: Particle Count vs. Size

Hydrometer Testing

A hydrometer test was performed on ground silica and street dust to confirm the PSD test results performed by the FPIA. The hydrometer test calculates the diameter of the particles by mass. The specific gravities used in the calculation were assumed to be 2.65 for ground silica and 2 for street dust. The hydrometer test results for ground silica and street dust are shown in Figure 11 alongside a translation of the FPIA particle count to a mass-based PSD. This calculation assumed spherical particles and a particle density of 2.65. Calculations are shown in Appendix A.

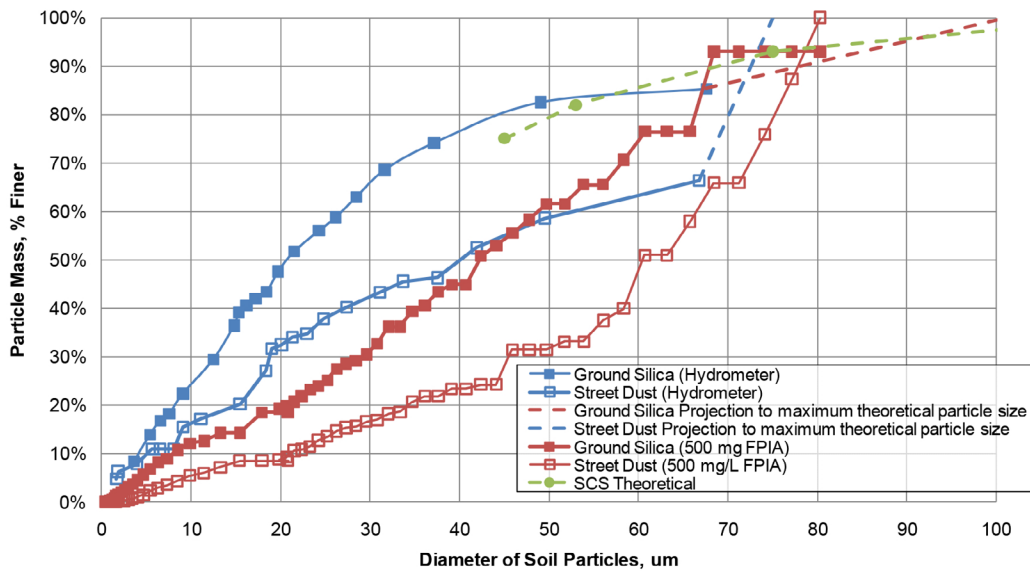

Figure 11. Mass based PSD comparison of ground silica and street dust

Both the hydrometer test results and the FPIA PSD results show that ground silica particles are generally smaller than street dust particles. The comparison between the two methods, however, shows that the hydrometer method consistently show smaller particle sizes than what is calculated from FPIA analysis. It could not be determined in this project which result was more accurate. However, the product data provided by the ground silica manufacturer (ECY, 2002) is very similar to the hydrometer results shown in Figure 11, but the manufacturer could have used a hydrometer to obtain their results. The lack of agreement between FPIA and hydrometer tests does not impact the validity of the results of the water quality and hydraulic analysis in this report. The primary point to these results is that both methods agree that ground silica is finer than street dust, which indicates that ground silica may not be the best source of sediment for estimating field performance.

Image Comparison

Particle images were compiled while performing the PSD test using the FPIA. These images show that ground silica particles are more angular whereas the street dust particles are more round, as shown in Appendix A. Ground silica is much lighter in color than street dust. In bulk, ground silica appears white and street dust appears very dark brown to grey.

2.2.4 Slurry Preparation

For each test run, the amount of sediment required to produce the specified target influent concentration (100 or 200 mg/L, depending on the test) was calculated based on the design flow, the injection flow, and a TSS recovery rate of about 80 percent of the theoretical dose. The sediment was then weighed out and mixed with 13 gallons of water in a 20 gallon cylindrical tank with a conical bottom using a mixer and a circulation pump.

The peristaltic pump was calibrated to 0.067 gpm to inject the correct amount of slurry into the main water supply to achieve the desired influent concentration entering the test tank.

2.3 Sampling

Influent and effluent samples were collected from the corresponding outlets in a 1.0 L plastic bottle for preliminary testing and a 500 ml plastic bottle for long-term and street dust tests.¹ One liter plastic bottles were marked with 100 ml gradations and 500 ml plastic bottles were marked with 50 ml gradations. Aliquots were taken every 15 minutes for 150 minutes creating a composite of ten aliquots per sample of both the influent and the effluent. Since flow was consistent (+/- 10 percent of target flow), these timeweighted composites are also flow-weighted composites.

2.4 Analysis

Various analyses were performed on the influent and effluent of each test. Some analyses were performed by OWP and other analyses were performed by Caltest, an analytical laboratory in Napa, CA. Table 3 is a summary of analyses performed.

Table 3. Summary of analysis performed.

Analysis	TSS Verification Test	Long-term Ground Silica Test	Street Dust Test
Total Suspended Solids (TSS)	Caltest	Caltest	OWP
Suspended Solids Concentration (SSC)	OWP	OWP	OWP
Particle Size Distribution (PSD)	OWP	OWP	OWP
Turbidity	OWP	OWP	OWP
Total Phosphorus			Caltest
Orthophosphate			Caltest
Total Kjeldahl Nitrogen			Caltest
Nitrate			Caltest
Total Copper ^a			Caltest
Total Aluminum ^a			Caltest
Dissolved Aluminum ^a			Caltest
Total Zinc ^a			Caltest
Dissolved Zinc ^a			Caltest

a. Not part of original set of constituents to be analyzed. See Section 5.2.1 for explanation.

¹ Bottles differed in size at the request of the analytical laboratory where particular analyses are performed (see Section 2.4) due to the largely unnecessary amount of sample provided in a 1.0 L bottle and due to space constrictions at the laboratory.

3 Preliminary Testing

3.1 Protocol

The protocols for the preliminary tests are described in this section. These Perk Filter™ configurations are referred to as M1T1, M1T2, as discussed in Table 2.

3.1.1 Hydraulic Verification

New M1T1 filters were installed in the tank in the hydraulics lab at Sacramento State to determine the hydraulic capacity. At various flow intervals, the water level in the tank was allowed to stabilize. When the water stabilized, flow and water level measurements were recorded. This process was repeated until the tank reached maximum capacity.

During the first hydraulic verification the configuration of the filters allowed water to only flow through the top filter. So, a second hydraulic verification test was performed on M1T2 filters to test the flow through both the top and the bottom filters.

3.1.2 Total Suspended Solids Verification

M1T2 filters were moved to the OWP outdoor laboratory to perform the total suspended solids (TSS) verification test. The test was performed to estimate the TSS removal performance of Kristar's Perk Filter™ prior to the long-term test and to verify that treatment is similar to that observed in the 2007 tests. Three tests were performed with an influent concentration of 100 mg/L and a design flow rate of 13.6 gpm. Influent and effluent samples were taken for TSS, SSC, PSD, and turbidity analysis. The sample schedule for the test is shown below in Table 4.

Table 4. Sample schedule for the TSS verification test.

Run	Street Dust, kg		Flow %	Gpm	Approximate Gallons of Water	
	kg/test	Total			Gallons/Test	Cumulative
1	1.275	1.275	100%	13.6	2,040	2,040
2	1.275	2.55	100%	13.6	2,040	4,080
3	1.275	3.825	100%	13.6	2,040	6,120

3.2 Results

The results for the preliminary tests for hydraulic performance and TSS removal are described herein.

3.2.1 Hydraulic Verification

The hydraulic capacity of M1T1 was 46 gpm and M1T2 was 42.2 gpm at a water level of 30 inches. Figure 12 compares M1T1 and M1T2 as the water level changes with flow.

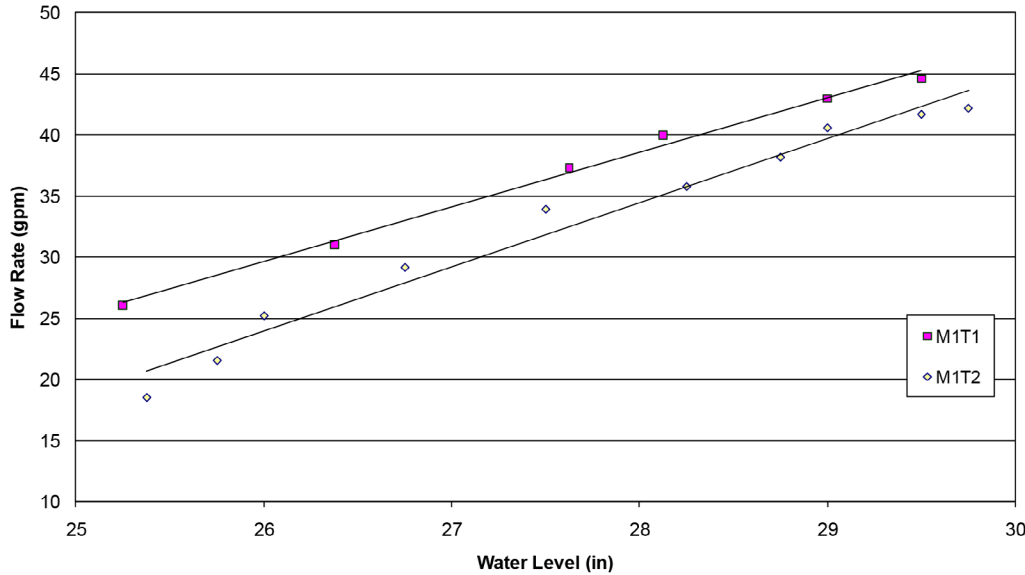

Figure 12. M1T1 and M1T2 hydraulic capacity results.

3.2.2 Total Suspended Solids Verification

The desired influent concentration was met within +/- 10 percent, but the performance results were lower than the 2007 Perk Filter™ performance results. Removal performance results for the TSS verification test ranged from 71 percent to 59 percent, averaging 66 percent, as shown in Figure 13. The 2007 TSS removal performance results at approximately 13.6 gpm averaged about 80 percent (OWP, 2007).



Figure 13. M1T2 performance results compared to 2007 Perk Filter™ results at 13.6 gpm.

4 Long-Term Ground Silica Test

The goal of the long-term ground silica test is to show that the Perk Filter™ could consistently remove sediment throughout a prolonged loading period that approximates annual loading. Removal is expected to increase with loading for surface-dominated filtration, but eventually loading will clog the filter and cause bypass.

The test used 165,000 gallons of water, which is equivalent to 29.2 inches of runoff from a 0.19 acre catchment using a runoff coefficient of 0.9. The catchment was calculated using a design intensity of 0.2 in/hr, a 0.9 runoff coefficient, and a design flow of 17 gpm. The filter was loaded with 125 kg of ground silica, an increase of 110 kg over the previous test.

4.1 Protocol

MIT2 filters were used for the long-term ground silica test at the OWP outdoor laboratory. Forty-six runs were performed with an influent concentration of 200 mg/L at a design flow rate of 24 gpm. A higher flow was used to shorten the time needed to run the experiment. Influent and effluent samples were taken for TSS, SSC, PSD, and turbidity analysis for ten of the 46 runs. The sample schedule for the test is shown below in Table 5.

Table 5. Sample schedule for the long-term ground silica test.

Run	Street Dust, kg		Flow		Approximate Gallons of Water		Duplicate
	kg/test	Total	%	Gpm	Gallons/Test	Cumulative	
5	4	20	100%	24.0	3,600	18,000	
11 ^a	4	44	100%	24.0	3,600	39,600	
15	4	60	100%	24.0	3,600	54,000	
20	4	80	100%	24.0	3,600	72,000	
25	4	100	100%	24.0	3,600	90,000	X
30	4	120	100%	24.0	3,600	108,000	
35	4	140	100%	24.0	3,600	126,000	
40	4	160	100%	24.0	3,600	144,000	
46	4	184	100%	24.0	3,600	165,600	X

a. Staff scheduling conflicts did not allow sample collection on run 10

To corroborate the performance based on influent and effluent concentrations, a mass balance was performed. At the completion of the test, the MIT2 filter media was emptied in a container to measure the volume of the media. Then the container was filled with a known volume of water to estimate the void space within the spent media. The void space of new media was estimated in the same way. The total volume of the spent media was subtracted by the volume of fresh media to estimate the volume of ground silica that was retained in the spent media. The mass of ground silica was calculated using a specific gravity of

2.65. This mass was added to the dry mass captured outside the filter, but within the test tank, to obtain the total mass of captured ground silica. The mass balance was calculated using this mass and the influent mass as determined by concentrations and flow measurements.

4.2 Results

Removals versus loading results are graphed in Figure 14. Although TSS and SSC results show a slight increase in removal performance as the load increases, the correlation is very weak, as shown by the low coefficient of correlation value. The average TSS and SSC removal performance results for the M1T2 filters for the long-term test was approximately 23 percent with a 90 percent confidence interval of 18 to 28 percent, as shown in Figure 15.

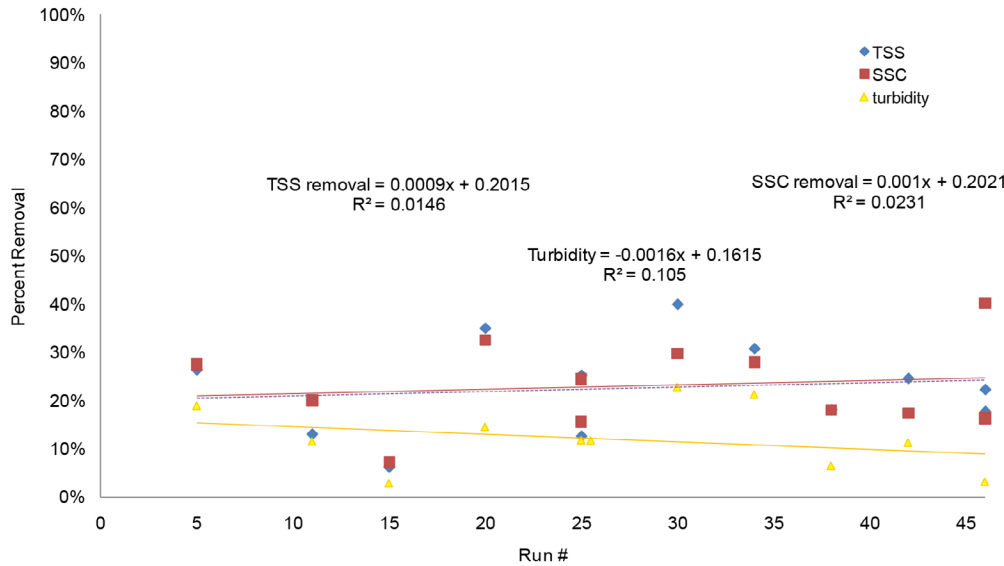

Figure 14. M1T2 long-term TSS, SSC, and turbidity performance results.

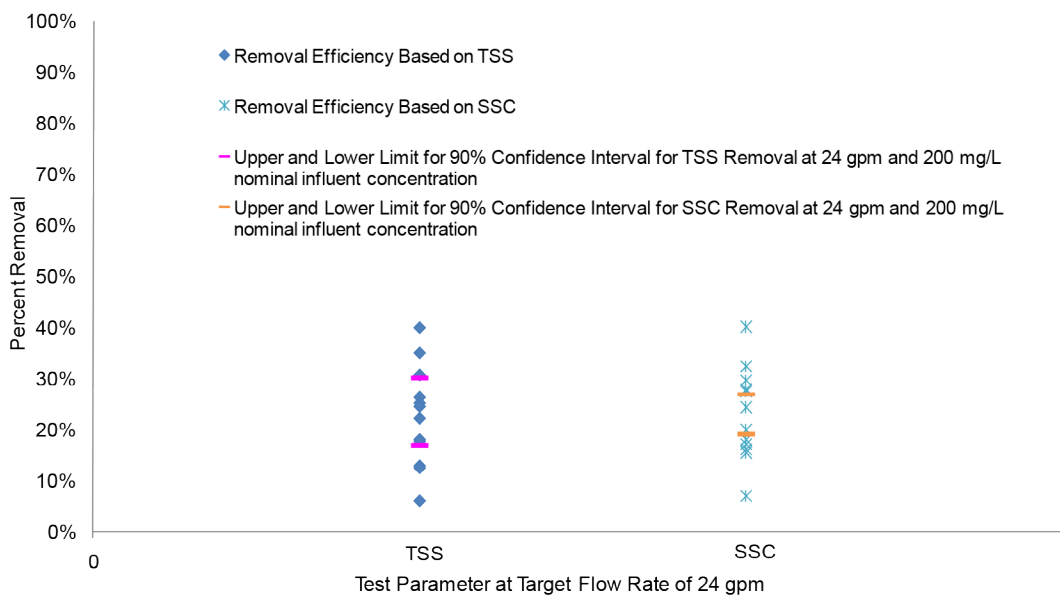

Figure 15. M1T2 performance results compared to ECY DOE treatment standards.

Removal performance results were substantially lower than the 2007 Perk Filter™ average removal efficiency of 65 percent, and the average removal of 23 percent did not meet ECY DOE pretreatment standard. Consequently, the filters were deconstructed and evaluated. Layers of ground silica, zeolite, and perlite were found throughout the filters. The layers restricted the flow through the filters, causing ground silica particles to move at a higher velocity through more porous media and thus increasing particle momentum and decreasing removal efficiency. This follows the theory of breakthrough in a depth filter as described in various water quality treatment texts (e.g., Reynolds and Richards, 1996). The higher velocities also caused higher TSS loading on the media that was not blinded by ground silica.

As a result of these observations and marginal performance, the filter media partition was reinstalled for the subsequent street dust test. Because of large density differences between perlite and zeolite, partitioning the perlite and zeolite-carbon mixture reduces the chance of layers of media forming.

Though a trend with increasing instantaneous loading is not apparent with the long-term loading experiment, consideration of the verification phase indicates a decrease in performance. A test of significance of this test was not performed because the two tests had differing influent concentrations. These observations are presented as anecdotal evidence of a decrease in performance. This led to the adjustments in filter configurations for future tests.

The mass balance performed on MIT2 confirms the performance observed from the concentration data. The average TSS removal efficiency of the filters based on the mass balance is 20 percent compared to the average removal efficiency of 23 percent from influent and effluent concentrations. See Appendix A for calculations.

5 Street Dust Testing for TSS, TN, TP, and Metals

Ground silica, used to represent stormwater particles in all previous Perk Filter™ tests, does not represent the composition and shape of actual stormwater particles. To better represent the field performance of the Perk Filter™, street dust was used to load new M2T2 filters. Street dust obtained from street sweepings consists of particles passing US sieve size #200, which has an apparent opening of 0.075 mm.

M2T2 filters partitioned the perlite and zeolite-carbon mix with a staff screen as in the 2007 Perk Filter™ design. M2T2 filters are described in Section 1.2. The protocol specific to testing with street dust is described in Section 5.1. Results are presented in Section 5.2, including an exploration of the relationship of constituent removal to filter loading and to flow. An analysis of variance of the regression was performed and is presented in Section 5.2.2. The analysis was not possible for percent removal versus loading because the test did not replicate loading.

5.1 Protocol

5.1.1 Scheduled Test

Fifteen runs were performed with a target influent concentration of 100 mg/L at a flow rate of 125, 100, 75, 50, and 25 percent of 27 gpm.² Influent and effluent sample sets, as well as three duplicate samples sets, were analyzed for TSS, SSC, PSD, and turbidity, as well as total phosphorus, total kjeldahl nitrogen, orthophosphate, and nitrate. Each sample set was analyzed. The sample schedule for the test is shown in Table 6.

Table 6. Sample schedule for Street Dust Test – Runs 1 through 15.

Run	Street Dust, kg		Flow		Approximate Gallons of Water		Duplicate
	kg/test	Total	% of design flow	Gpm	Gallons/Test	Cumulative	
1	1.104	1.104	50%	13.5	2,025	2,025	
2	1.104	2.208	50%	13.5	2,025	3,825	
3	1.104	3.312	50%	13.5	2,025	5,625	
4	2.751	6.063	125%	33.7	5,063	10,125	
5	2.751	8.814	125%	33.7	5,063	14,625	X
6	2.751	11.565	125%	33.7	5,063	19,125	
7	2.202	13.767	100%	27.0	4,050	22,725	
8	2.202	15.969	100%	27.0	4,050	26,325	
9	2.202	18.171	100%	27.0	4,050	29,925	
10	1.653	19.824	75%	20.3	3,038	32,625	X
11	1.653	21.477	75%	20.3	3,038	35,325	

² Design flow was selected by Kristar.

Run	Street Dust, kg		Flow		Approximate Gallons of Water		Duplicate
	kg/test	Total	% of design flow	Gpm	Gallons/Test	Cumulative	
12	1.653	23.13	75%	20.3	3,038	38,025	
13	0.555	23.685	25%	6.8	1,013	38,925	
14	0.555	24.24	25%	6.8	1,013	39,825	
15	0.555	24.795	25%	6.8	1,013	40,725	X

Design Flow Rate = 27 gpm

5.1.2 Additional Runs

Due to influent dosing problems, run 5 was replaced by run 16. Run 11 was not consistent with the other two runs (10 and 12) at the same flow rate, but there was insufficient evidence to replace run 11. Instead, two additional runs at 20 gpm were performed to increase the confidence in the estimation of average removal efficiency.

For the originally scheduled fifteen runs, results include “non detect” results for nitrate. Because nitrate was not detected in the influent, the nitrate analysis was replaced with copper analysis for runs 16 through 18. The sample schedule for the additional runs is shown below in Table 7.

Table 7. Sample schedule for Street Dust Test – Runs 16 through 18.

Run	Street Dust, kg		Flow		Approximate Gallons of Water		Relation to Original Runs
	kg/test	Total	% of design flow	Gpm	Gallons/Test	Cumulative	
16	2.751	27.546	125%	33.7	5,063	50,625	Replaces Run 5
17	1.653	29.199	75%	20.3	3,038	53,663	Augments Runs 10-12
18	1.653	30.852	75%	20.3	3,038	56,700	Augments Runs 10-12

Design Flow Rate = 27 gpm

After the above runs and analysis were complete, there arose a need for metals data. The residual water samples left over from FPIA analysis, runs 1 – 4 and 6 – 18, was analyzed for total copper, aluminum, and zinc. The results are presented in Section 5.2.1.

5.1.3 Additional Modification and Hydraulic Test

After the completion of the runs, a final hydraulic check was performed at the outdoor laboratory following the same protocol for preliminary testing as described in Section 3.

The results of the hydraulic test are presented in Section 5.2.3.

5.2 Results

Because previous tests were performed with ground silica, the results of the street dust test cannot be compared to any previous tests performed on the Perk Filter™. Ground silica and street dust have different

chemical compositions, specific gravities, reflectivity, and shape. See Section 2.2.3 for a comparison between the two sediments.

5.2.1 Scheduled Test and Additional Runs

The M2T2 Perk Filter™ configuration performed better than M1T2. This could be due to segregation of filter media and because a different sediment was used. The average TSS removal performance results for the M2T2 filters for the street dust test was approximately 67 percent for runs 1 through 4 and 6 through 18, compared to the average removal of 23 percent for the M1T2.

As mentioned earlier, run 5 was replaced with run 16 due to influent dosing problems, and runs 10-12 (20.2 gpm) were augmented by run 17 and 18. Street dust test results are presented in Table 8.

Table 8. M2T2 TSS results and statistics.

Run #	Flow Rate:		Influent TSS, mg/L ^a	Removal efficiency ^a	Avg	Std Dev	95% Confidence Limits	
	% of design flow	GPM					Upper	Lower
1	50%	13.5	101	92%	88%	0.056	98%	79%
2			107	91%				
3			88	82%				
4	125%	33.7	77	60%	53%	0.078	67%	40%
16 ^b			105	45%				
6			104	56%				
7	100%	27.0	105	43%	38%	0.042	45%	31%
8			107	36%				
9			109	35%				
10 ^{c,d}	75%	20.3	98.5	68%	54%	0.144	68%	40%
11 ^d			101	31%				
12 ^d			95	63%				
17 ^d			83	53%				
18 ^d			98	55%				
13	25%	6.8	95	93%	90%	0.021	94%	87%
14			97	89%				
15 ^c			91	90%				
Averages =			98	64%				

^a. Yellow – Influent; Blue – Removal efficiency; Red – Data replaced; Orange – Data inconsistent with performance at similar flow rates.

^b. Run 5 replaced by run 16.

^c. Duplicate – sample 10a,b were averaged; sample 15a,b were averaged.

^d. Run 10–12 are augmented by run 17 and 18.

5.2.2 Regressions of percent removal versus load for TSS, SSC, and turbidity and percent removal versus flow for all constituents

Percent removal results versus loading graphs are shown in Figures 16 a through f. No obvious relationship between removal efficiency and the increasing load was observed for M2T2 filters for most flows. The

slopes on these graphs appear to be near zero. The lack of a slope indicates that the filters have not fully clogged. Section 5.2.4 discusses clogging observed in the later runs. See Appendix B for SSC results.

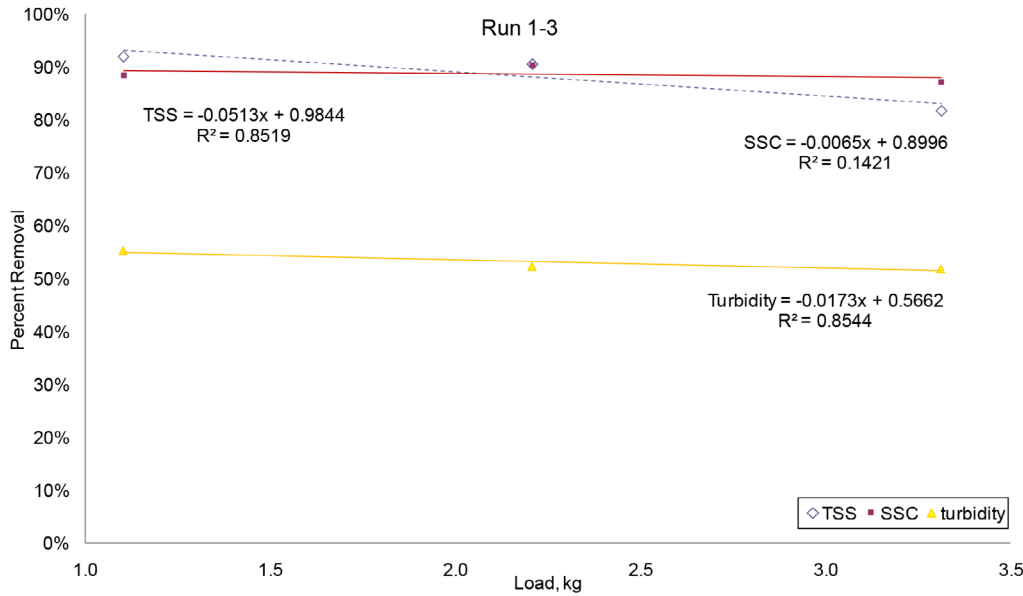

Figure 16 a. M2T2 percent removal vs. instantaneous loading for runs 1 to 3.

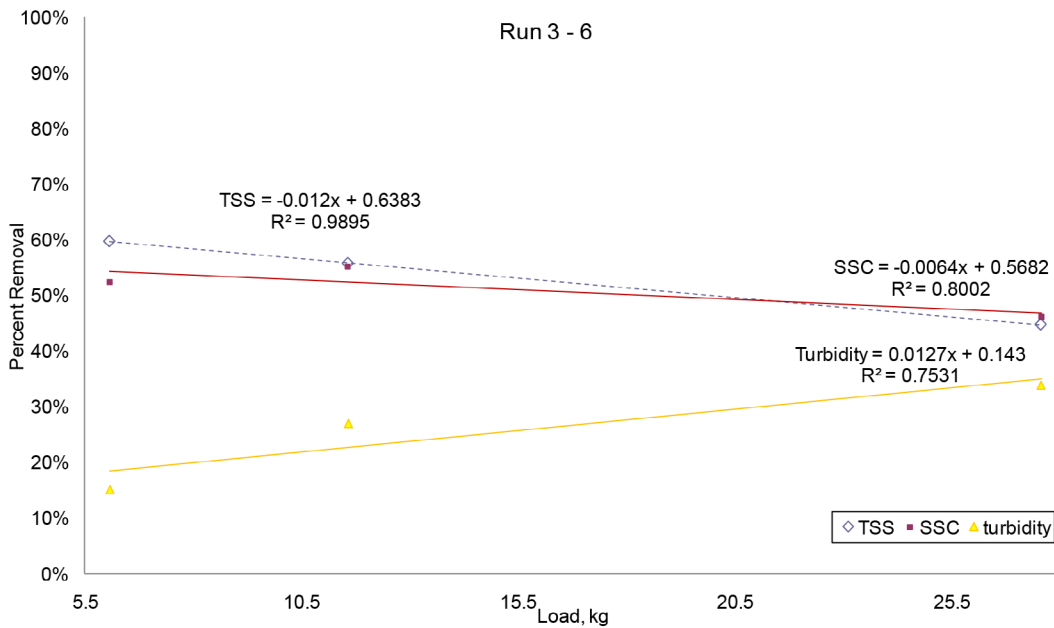

Figure 16 b. M2T2 percent removal vs. instantaneous loading for runs 3 to 6, and 16.

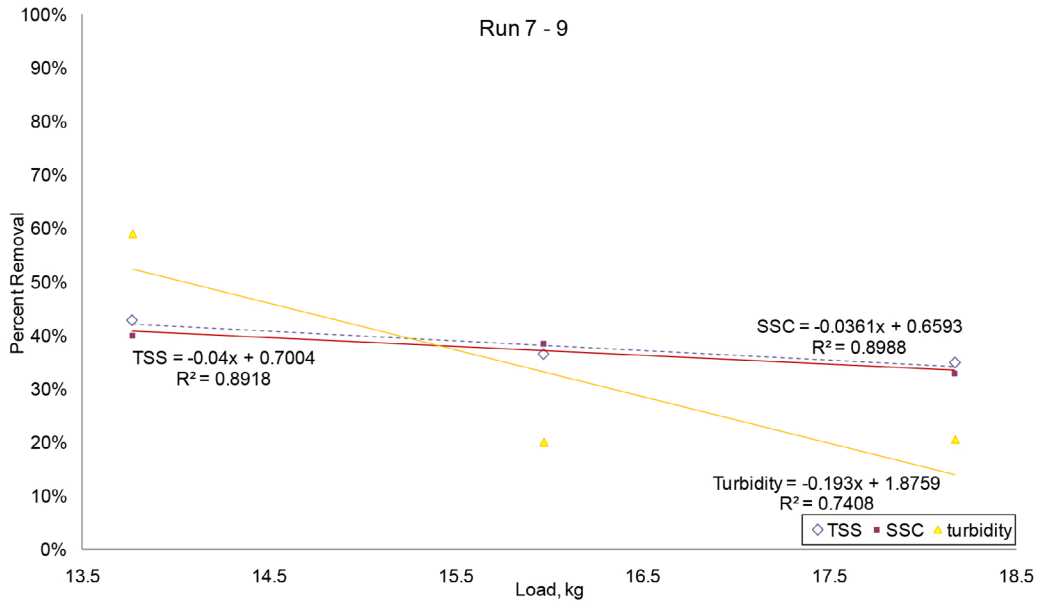

Figure 16 c. M2T2 percent removal vs. instantaneous loading for runs 7 to 9.

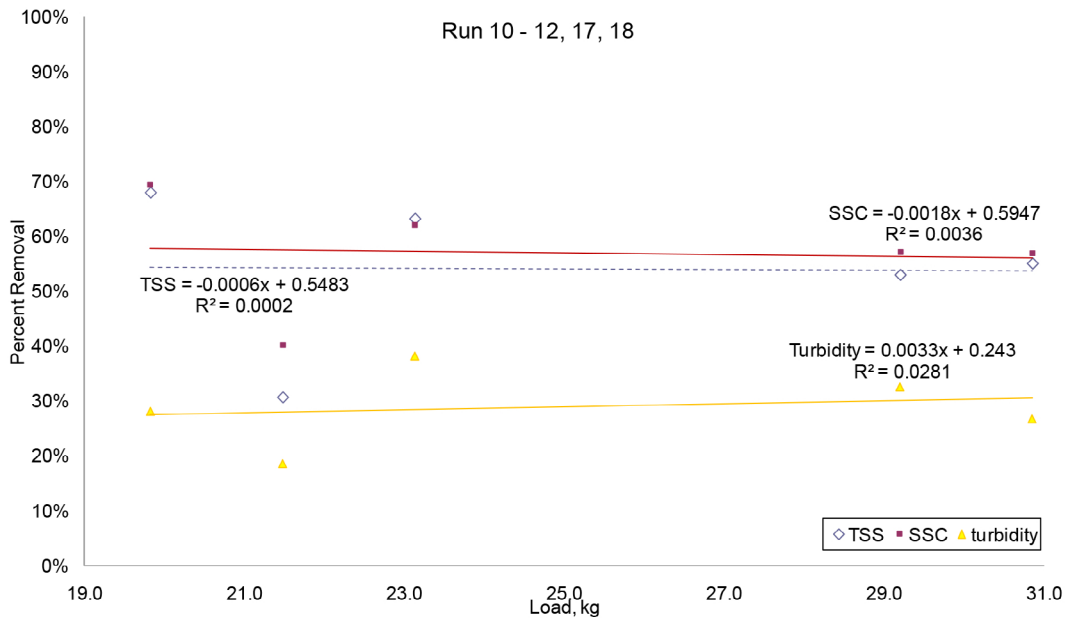

Figure 16 d. M2T2 percent removal vs. instantaneous loading for runs 10 to 12, 17 and 18.

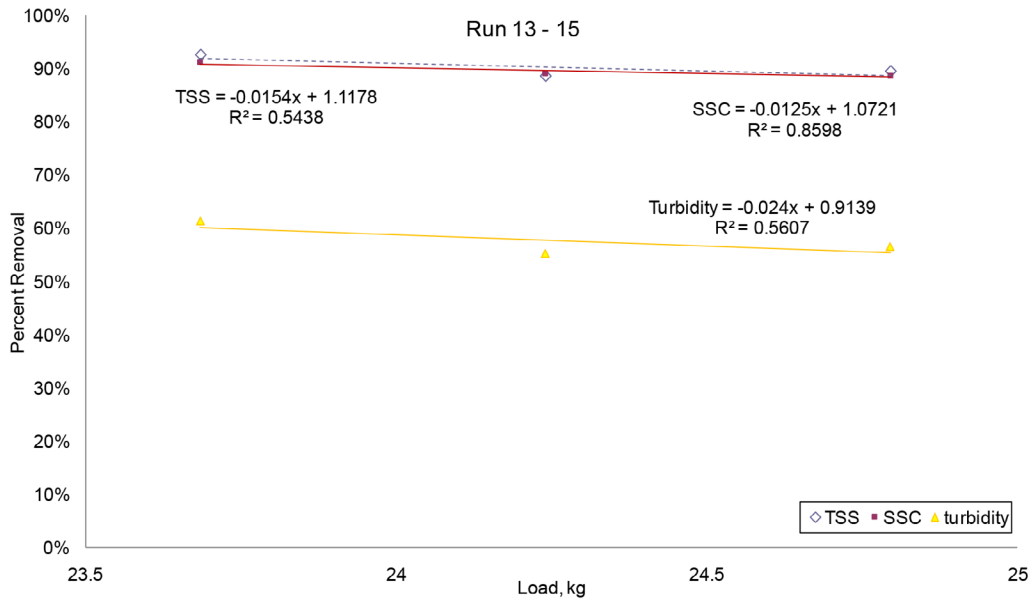

Figure 16 e. M2T2 percent removal vs. instantaneous loading for runs 13 to 15.

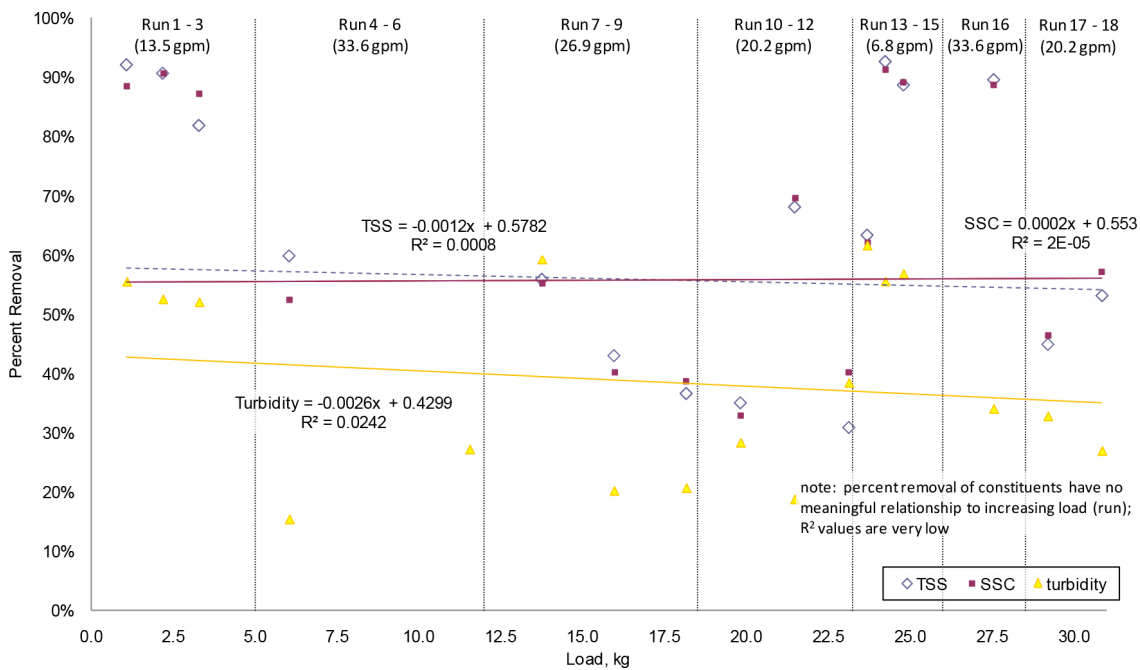

Figure 16 f. M2T2 TSS, SSC, and turbidity results as load increases.

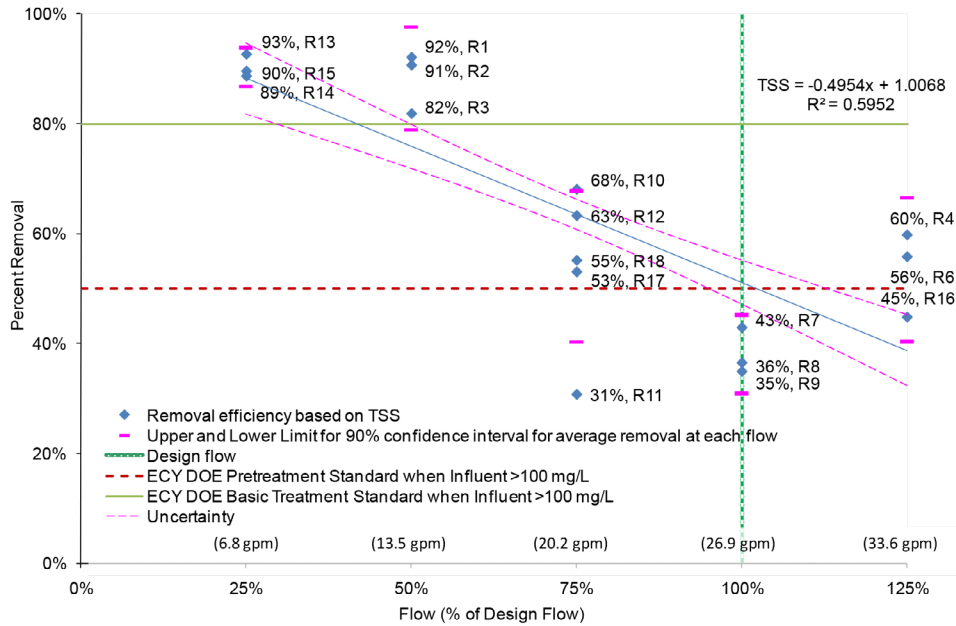

Figure 17. M2T2 TSS results VS. flow, compared to ECY DOE treatment standards.

The trend for removal efficiency versus flow is shown in Figure 17. As flow increases, removal performance decreases. Figure 17 also compares performance to the State of Washington’s Department of Ecology (ECY DOE) Basic Treatment and Pretreatment performance standards (ECY, 2002). The Perk Filter™ was not tested with a typical pretreatment chamber, which would have increased removal and thus may have allowed for higher design flows.

Phosphorus Analysis

Runs 1–15 were analyzed for total phosphorus and orthophosphate and results are shown in Table 9 and Figure 18. The ECY DOE standard for total phosphorus is 50 percent removal efficiency for influent total phosphorus concentrations of 0.1 to 0.5 mg/L when the Basic Treatment standards are met. Flow at 6.8 gpm consistently met the Basic Treatment standard, but the mean linear regression predicts 50 percent removal at about 13 gpm.

Table 9. M2T2 total phosphorus results and statistics.

Run #	Flow Rate:		Influent P, mg/L ^a	Removal Efficiency ^a	Avg	Std Dev	95% Confidence Limits	
	% of design flow	GPM					Upper	Lower
1	50%	13.5	0.16	41%	40%	0.028	45%	36%
2			0.16	38%				
3			0.13	43%				
4	125%	33.7	0.1	20%	28%	0.079	42%	15%
16 ^b			0.17	29%				
6			0.14	36%				

Run #	Flow Rate:		Influent P, mg/L ^a	Removal Efficiency ^a	Avg	Std Dev	95% Confidence Limits	
	% of design flow	GPM					Upper	Lower
7			0.12	18%				
8	100%	27.0	0.12	18%	17%	0.005	18%	16%
9			0.12	17%				
10 ^{c,d}			0.13	47%				
11 ^d			0.11	20%				
12 ^d	75%	20.3	0.11	45%	31%	0.141	45%	18%
17 ^d			0.11	17%				
18 ^d			0.12	27%				
13			0.77	94%				
14	25%	6.8	0.094	70%	74%	0.182	105%	43%
15 ^c			0.08	58%				
Averages =			0.16	37%				

- ^a. Yellow – Influent; Blue – Removal efficiency; Red – Data replaced; Orange – Data inconsistent with performance at similar flow rates.
- ^b. Run 5 replaced by run 16.
- ^c. Duplicate – sample 10a,b were averaged; sample 15a,b were averaged.
- ^d. Run 10–12 are augmented by run 17 and 18.

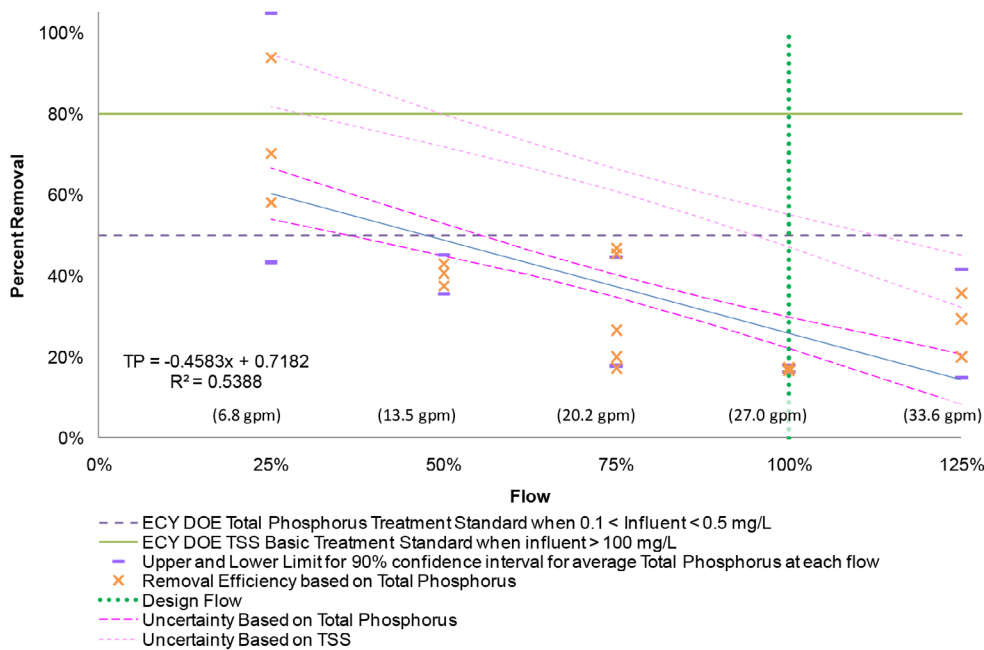

Figure 18. M2T2 total phosphorus results compared to TSS and ECY DOE treatment standards.

Orthophosphate removal results are shown in Table 10 and Figure 19. Orthophosphate uncertainty calculations for 13.5 gpm are omitted because of non-detects.

Table 10. M2P2 orthophosphate results and statistics.

Run #	Flow Rate:		Influent P, mg/L ^a	Removal Efficiency ^a	Avg	Std Dev	95% Confidence Limits	
	% of design flow	GPM					Upper	Lower
1			0.007	-				
2	50%	13.5	0.13	79%	63%	0.223	-	-
3			0.065	48%				
4			0.047	6%				
16 ^b	125%	33.7	0.075	20%	11%	0.082	24%	-3%
6			0.019	5%				
7			0.048	15%				
8	100%	27.0	0.065	29%	17%	0.109	36%	-1%
9			0.05	8%				
10 ^{c,d}			0.036	15%				
11 ^d			0.035	9%				
12 ^d	75%	20.3	0	40%	20%	0.117	31%	9%
17 ^d			0.06	18%				
18 ^d			0.059	17%				
13			0.048	44%				
14	25%	6.8	0.037	46%	42%	0.055	51%	32%
15 ^c			0.031	35%				
Averages =			0.05	27%				

^a. Yellow – Influent; Blue – Removal efficiency; Red – Data replaced; Orange – Data inconsistent with performance at similar flow rates.

^b. Run 5 replaced by run 16.

^c. Duplicate – sample 10a,b were averaged; sample 15a,b were averaged.

^d. Run 10–12 are augmented by run 17 and 18.

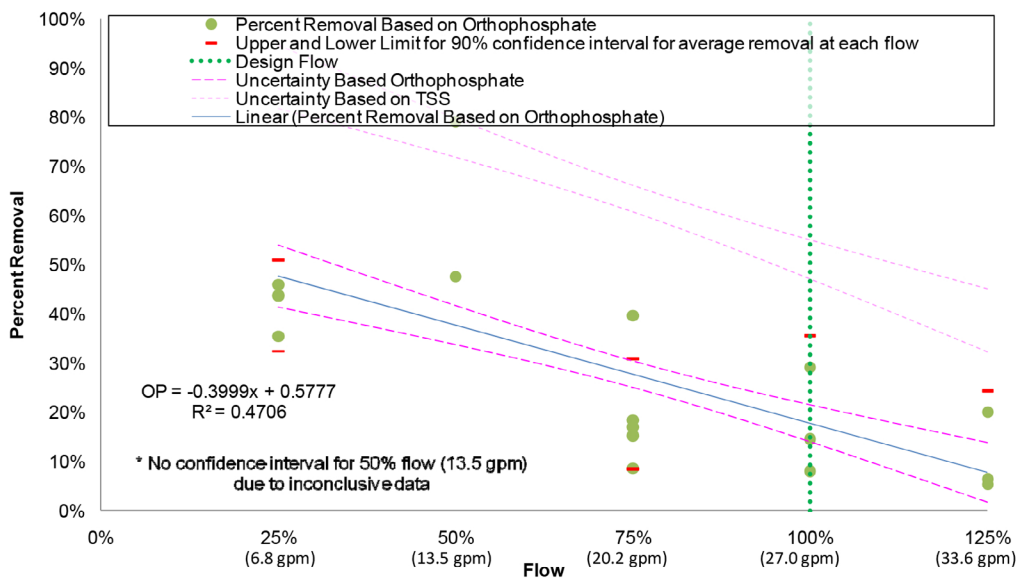

Figure 19. M2T2 orthophosphate results.

5.2.3 Nitrogen Analysis

Total Kjeldahl Nitrogen (TKN) and nitrate had too many non-detect values to report performance results.

5.2.4 Metals Analysis

The Perk Filter™ removed an average of 51 percent of the total copper, an average of 51 percent of total aluminum, and an average of 43 percent of total zinc. As with TSS and phosphorus, metals and TSS share a similar trend in removal rate versus flow rate. As with phosphorus, removal efficiency of metals is less than TSS. This may be due to TSS being a measure of particulate matter that is more easily filtered, while metals include the dissolved fraction that is not filterable. See Tables 11 through 13 and Figures 21 through 23 for results.

In Figure 21, copper removal decreases with increasing flow, but not as rapidly as predicted with TSS. This could be because TSS spans a broader spectrum of particle sizes and less dense particles pass more easily through the filter at higher flows. Copper, conversely, is made of very dense mineral and anthropogenic sources along with a dissolved fraction due to equilibrium chemistry between solid and dissolved phases. This may be resulting in much less of a continuum in particle size, but rather a bimodal distribution of particles sizes. It could be that the particulate phase, because of its high density, is better removed at higher flows than the same size particles associated with TSS. The dissolved fraction of copper, not being removed very well at low flows, would fare not worse at higher flows. The similarity in the slopes between the regressions for TSS and total copper, however, indicates that the difference in slope may not be significant.

In Figure 22, the slope of the aluminum removal more closely matches the slope of TSS removal. The same is true for zinc as seen in Figure 23. From a design standpoint, however, the differences in performance among these metals do not appear substantially different. This information could be relevant to economizing future testing.

The variation in performance is explored in Section 5.2.5.

Table 11. M2T2 total copper results and statistics.

Run #	Flow Rate:		Influent TCu, mg/L ^a	Removal Efficiency ^a	Avg	Std Dev	95% Confidence Limits	
	% of design flow	GPM					Upper	Lower
1			28	57%				
2	50%	13.5	31	68%	62%	0.053	0.7133	0.5346
3			26	62%				
4			18	28%				
16 ^b	125%	33.7	48	40%	35%	0.065	0.4626	0.2429
6			26	38%				
7			31	45%				
8	100%	27.0	38	45%	45%	0.006	0.4568	0.4352
9			41	44%				

Run #	Flow Rate:		Influent TCu, mg/L ^a	Removal Efficiency ^a	Avg	Std Dev	95% Confidence Limits	
	% of design flow	GPM					Upper	Lower
10 ^{c,d}	75%	20.3	34	54%	48%	0.117	0.5897	0.3664
11 ^d			40	45%				
12 ^d			49	61%				
17 ^d			30	30%				
18 ^d			31	48%				
13	25%	6.8	35	66%	65%	0.010	0.6647	0.6296
14			33	64%				
15 ^c			35.5	65%				
Averages =			33.79	51%				

- ^a. Yellow – Influent; Blue – Removal efficiency; Red – Data replaced; Orange – Data inconsistent with performance at similar flow rates.
- ^b. Run 5 replaced by run 16.
- ^c. Duplicate – sample 10a,b were averaged; sample 15a,b were averaged.
- ^d. Run 10–12 are augmented by run 17 and 18.

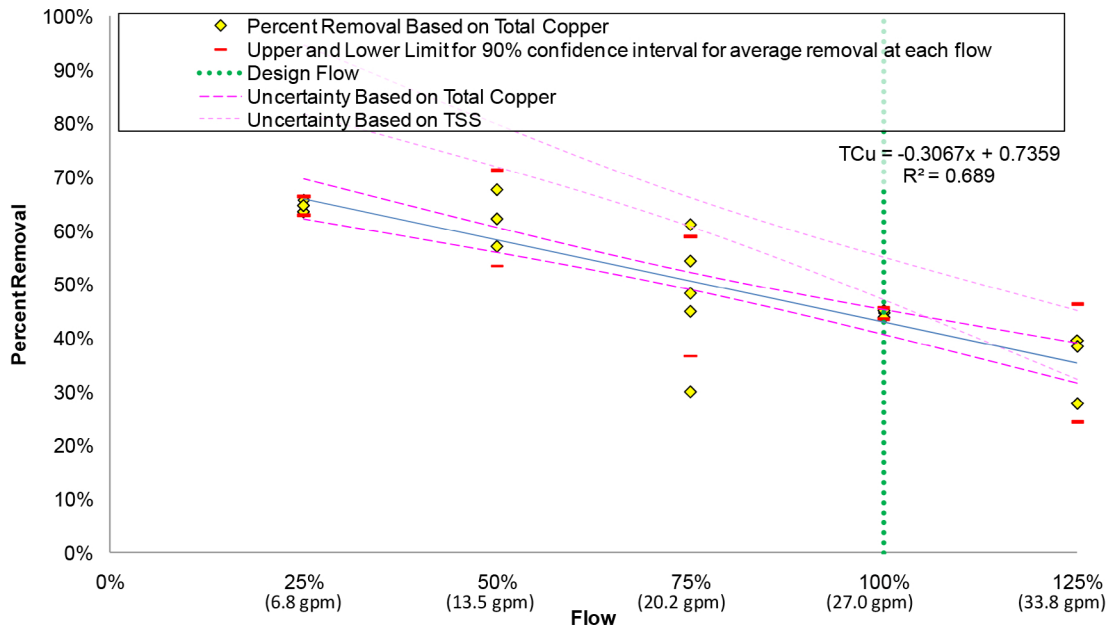

Figure 20. M2T2 total copper results.

Table 12. M2T2 total aluminum results and statistics.

Run #	Flow Rate:		Influent TAI, mg/L ^a	Removal Efficiency ^a	Avg	Std Dev	95% Confidence Limits	
	% of design flow	GPM					Upper	Lower
1			1600	74%				
2	50%	13.5	1600	84%	76%	0.070	0.8821	0.6471
3			1600	71%				
4			1100	32%				
16 ^b	125%	33.7	2100	43%	38%	0.056	0.4728	0.2843
6			1800	39%				
7			1800	33%				
8	100%	27.0	1800	28%	28%	0.049	0.365	0.1993
9			1700	24%				
10 ^{c,d}			1550	45%				
11 ^d			1700	24%				
12 ^d	75%	20.3	1600	71%	43%	0.176	0.6002	0.265
17 ^d			1500	37%				
18 ^d			1600	39%				
13			1500	75%				
14	25%	6.8	1900	76%	74%	0.021	0.776	0.7052
15 ^c			1450	72%				
Averages =			1641.18	51%				

^a. Yellow – Influent; Blue – Removal efficiency; Red – Data replaced; Orange – Data inconsistent with performance at similar flow rates.

^b. Run 5 replaced by run 16.

^c. Duplicate – sample 10a,b were averaged; sample 15a,b were averaged.

^d. Run 10–12 are augmented by run 17 and 18.

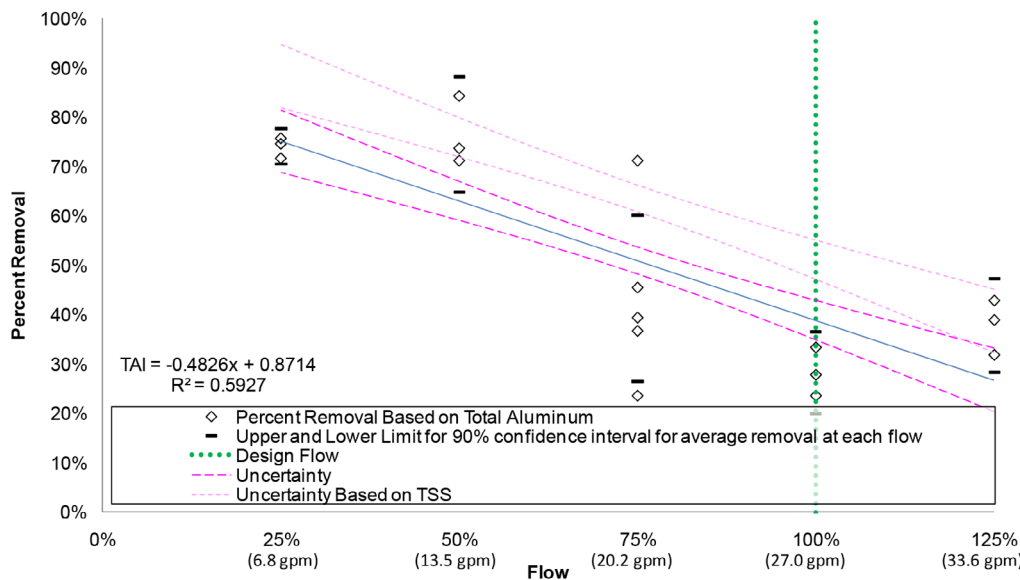

Figure 21. M2P2 total aluminum results.

Table 13. M2T2 total zinc results and statistics.

Run #	Flow Rate:		Influent TAI, mg/L ^a	Removal Efficiency ^a	Avg	Std Dev	95% Confidence Limits	
	% of design flow	GPM					Upper	Lower
1	50%	13.5	44	41%	57%	0.141	0.8046	0.3309
2			34	68%				
3			34	62%				
4	125%	33.7	24	13%	27%	0.123	0.473	0.0591
16 ^b			43	35%				
6			37	32%				
7	100%	27.0	41	32%	28%	0.031	0.3361	0.2319
8			43	28%				
9			43	26%				
10 ^{c,d}	75%	20.3	40	45%	38%	0.075	0.452	0.3097
11 ^d			43	28%				
12 ^d			46	46%				
17 ^d			32	34%				
18 ^d	32	38%						
13	25%	6.8	39	69%	69%	0.016	0.7196	0.6646
14			48	71%				
15 ^c			37	68%				
Averages =			38.82	43%				

- ^a. Yellow – Influent; Blue – Removal efficiency; Red – Data replaced; Orange – Data inconsistent with performance at similar flow rates.
- ^b. Run 5 replaced by run 16.
- ^c. Duplicate – sample 10a,b were averaged; sample 15a,b were averaged.
- ^d. Run 10–12 are augmented by run 17 and 18.

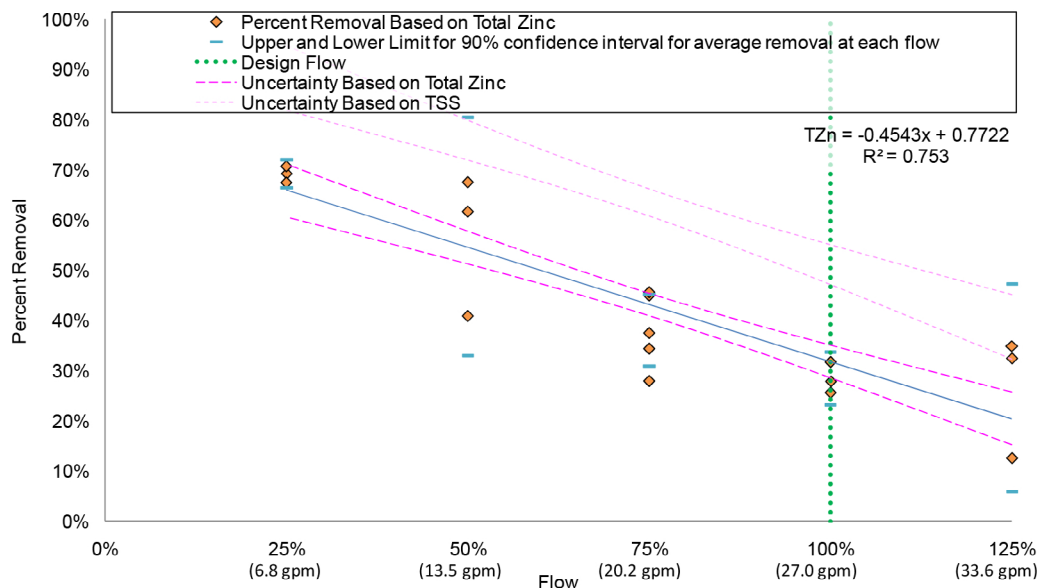

Figure 22. M2P2 total zinc results.

5.2.5 Analysis of Variation of Regression Analysis

The linear model of flow and performance may not sufficiently explain performance variability. To test this theory, the F ratio, a ratio of the sum of the squares based on the lack of fit of the repeated data and the sum of the squares based on the variance of the data at each flow, was compared to F critical. In all cases, except for copper and zinc, the F ratio exceeded the F critical value. While a higher-power model may be more appropriate, one must consider missing parameters before pursuing transformations of flow within the single-parameter model of performance versus flow. In this case, load should be considered in future mixed-model analysis. The values of the F ratio and F critical are shown below in Table 14. Calculations are in the Appendix A.

Table 14. F ratio and F critical values for each test parameter.

Test Parameter	F ratio	F critical
Total Suspended Solids	7.872988	
Suspended Solids Concentration	43.5095	
Total Phosphorus	4.462596	
Orthophosphate	4.79601	2.605525
Total Copper	0.594818	
Total Aluminum	3.943322	
Total Zinc	1.381816	

The relative value of the F-ratio can be seen in the departure of average performance at each flow in Figures 17 through 22. Among these figures, average copper removal at each flow has the least departure from the regression. Zinc follows, with aluminum being the worst of the metals. This is seen in the F-ratio, which is 0.6, 1.4, and 3.9 for copper, aluminum, and zinc, respectively. It is not known why copper, and metals in general, behave in a more linear fashion compared to sediment and phosphorus. It may be that metals are less sensitive to changes in the porosity of the filter media as discussed below.

Reevaluating the sediment removal versus increasing load can provide insight on why performance may be changing. M2T2 TSS removal efficiency results are graphed by increasing load, in Figure 23.

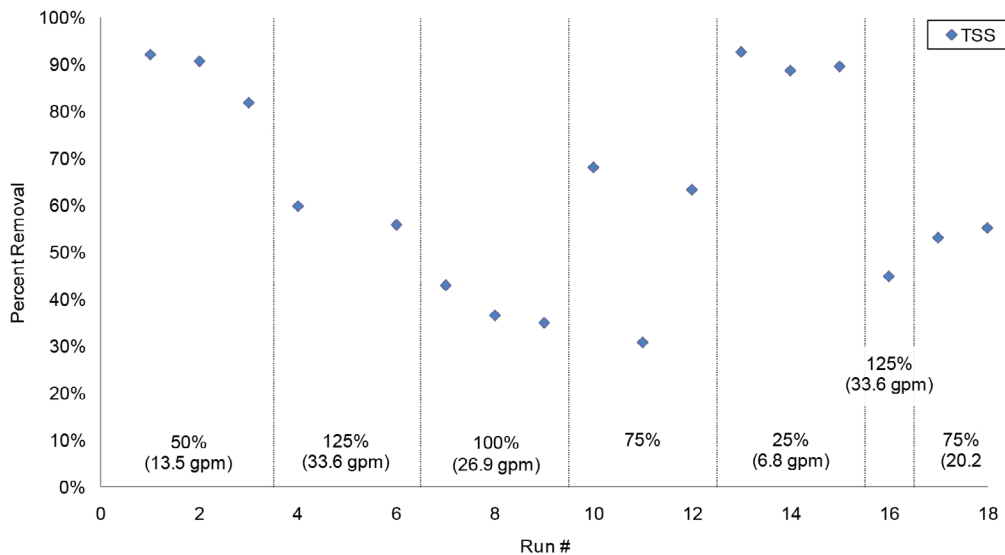

Figure 23. M2P2 TSS results by increasing load.

There are two phenomena which may contribute to the subtle decrease in performance.

There was also evidence of this phenomena in the long-term loading test, as discussed in Section 4.2. One phenomenon is that of particles filling interstitial spaces, which increase velocities and decreases removal. Another competing phenomenon is that of surface blinding, which was observed on the screens. This phenomenon could increase removal; however, there was no clear evidence that this occurred as seen in Figure 17. A possible explanation is that the particles may have matched the screen opening (aka pore matching) such that nearly complete clogging occurred through portions of the screen while unclogged portions passed water at higher velocities. This would explain the increase in head loss without substantial performance improvement.

The following observations were made based on significant changes in the influent, effluent, removal efficiency, and hydraulic head.

Throughout runs 1 through 9, the water level varied only slightly, which signifies low levels of surface clogging during the runs.

Within runs 10 through 15, there was a 1.5 to 2.0 inch increase in the water level, which indicates clogging. Since sediment was observed throughout the media, this could be the point at which the interstitial voids increased velocities enough to substantially increase head loss. At the same time, and possibly with greater effect, the screen on the central tube may have begun to blind as described above.

For Run 16 at 33 gpm, there was a 3 inch or more change in the water level, which signifies the filters were experiencing more clogging compared to the previous runs, but that may also be solely due to higher flow. Filters were heavily loaded with particles and the velocities through the remaining pore space of filter media were much higher than for runs 4 and 6 (also at 33 gpm). This may explain why performance was lower for run 16.

The clogging of the central screen was confirmed by the deconstruction and evaluation of the M2T2 filters, as described below.

5.2.6 Additional Modification and Hydraulic Test

The hydraulic capacity significantly dropped during runs 16–18, so the filters were deconstructed and evaluated. The screen surrounding the central tube perforations was clogged (Figure 24 a), which may have caused the significant drop in hydraulic capacity. To test this theory, the filters were reconstructed without a screen and a new central tube design was used. The new design had thinner slots so that media would not escape the central tube (Figure 24 b).



Figure 24. (a) M2T2 central tube design with screen. (b) M2T3 central tube design.

The M2T3 filters was tested using the spent media. The hydraulic capacity was almost that of the M2T2 filters with clean media. The results of the hydraulic capacity test are shown in Figure 25. This indicates that the reduction in hydraulic capacity was due primarily to screen clogging rather than media clogging.

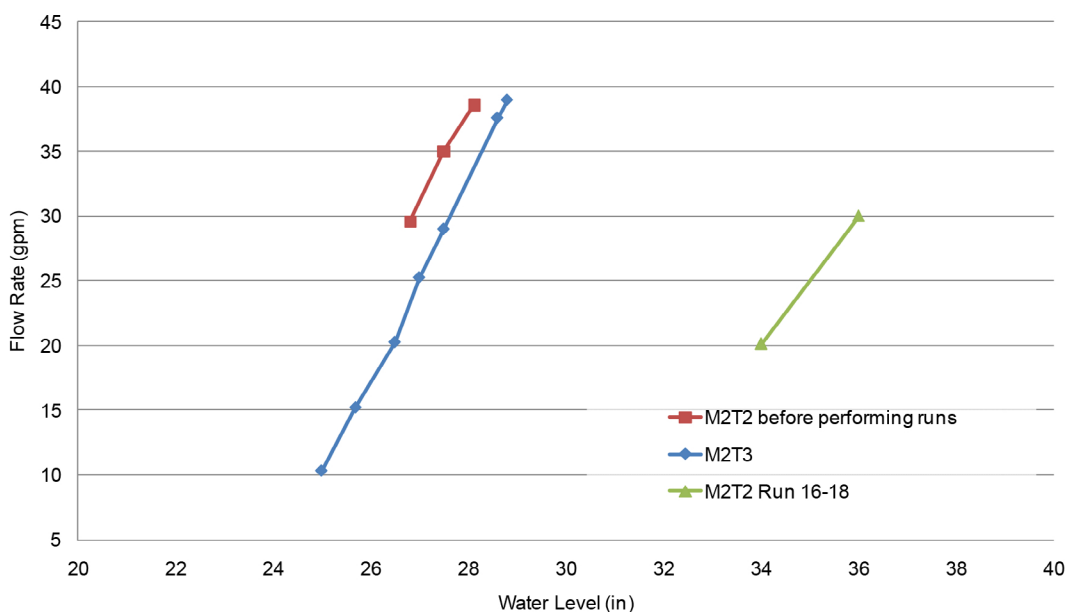

Figure 25. M2T2 and M2T3 hydraulic capacity results.

6 References

- Office of Water Programs (OWP). 2007. Perk Filter™ Final Report. Office of Water Programs, California State University, Sacramento. p. 18-21.
- Ecology (ECY). 2002; revised January 2008. Guidance for Evaluating Emerging Stormwater Treatment Technologies, Technology Assessment Protocol – Ecology (TAPE). Washington State Department of Ecology. <http://www.ecy.wa.gov/biblio/0210037.html> (accessed October 2, 2009). p. 4-5.
- Reynolds, T.D. and P.A. Richards. 1996. *Unit operations and processes in environmental engineering, 2nd edition*. Boston: PWS Publishing Co.
- U.S. Silica Company (USSC). 1997. Sil-Co-Sil 106. Product Data. <http://www.u-s-silica.com/PDS/Ottawa/OttSCS1062000.PDF> (accessed September 30, 2009).

APPENDIX A: Calculations

The 2007 Perk Filter™ loading summary for target influent concentrations of 100 mg/L and 200 mg/L for the zeolite-perlite-carbon filter are shown below.

2007 Perk Filter™ Loading Summary for Target Influent of 100 mg/L

Flow, %	125%	100%	75%	50%	25%	
Flow, gpm	30	24	18	12	6	Total
Runs	1	1	1	1	1	5
Time/run	150	150	150	150	150	150
Total Volume gallons	4,500	3,600	2,700	1,800	900	13,500
ft ³	601.60	481.28	360.96	240.64	120.32	1,804.81
acre-in	0.166	0.133	0.099	0.066	0.033	0.497
L	17,010	13,608	10,206	6,804	3,402	51,030
Concentration, mg/L	100	100	100	100	100	100
Total Load mg	1,701,000	1,360,800	1,020,600	680,400	340,200	5,103,000
kg	1.70	1.36	1.02	0.68	0.34	5.10
lb	3.74	2.99	2.25	1.50	0.75	11.23
Load/Catchment Rainfall depth lb/acre-in	22.58	22.58	22.58	22.58	22.58	22.58

2007 Perk Filter™ Loading Summary for Target Influent of 200 mg/L

Flow, %	125%	100%	75%	50%	25%	
Flow, gpm	30	24	18	12	6	Total
Runs	1	1	1	1	1	5
Time/run	150	150	150	150	150	150
Total Volume gallons	4,500	3,600	2,700	1,800	900	13,500
ft ³	601.60	481.28	360.96	240.64	120.32	1,804.81
acre-in	0.166	0.133	0.099	0.066	0.033	0.497
L	17,010	13,608	10,206	6,804	3,402	51,030
Concentration, mg/L	200	200	200	200	200	200
Total Load mg	3,402,000	2,721,600	2,041,200	1,360,800	680,400	10,206,000
kg	3.40	2.72	2.04	1.36	0.68	10.21
lb	7.48	5.99	4.49	2.99	1.50	22.45
Load/Catchment Rainfall depth lb/acre-in	45.16	45.16	45.16	45.16	45.16	45.16

The area that the 2007 ZPC Perk Filter™ is estimated to treat is based on the appropriate design flow, 17 gpm (OWP, 2007).

Area Treated by 2007 ZPC Perk Filter™

$$Q = CIA \rightarrow A = Q / CI$$

			Conversions	
Flow, Q =	17	Gpm	7.48	gal/ft ³
Runoff Coefficient, C =	0.9		12	in/ft
Rainfall Intensity, I =	0.2	in/hr	43560	sf/acre
			60	min/hr
Area, A =	0.21	Acres		

The rainfall that the 2007 ZPC Perk Filter™ is estimated to treat, 4.8 inches, is based on the total volume of water treated and the parameters, Q, C, I, and A, estimated above.

Rainfall Treated by 2007 ZPC Perk Filter™

			Conversions	
Concentration =	200	mg/L	3.785	L/gal
Runoff =	4.8	in	1,000,000	kg/mg
Total Volume =	27,000	Gal	2.2	lb/kg
Total Weight of Street Dust =	44.97	lb		

The long-term ground silica loading summary is shown below.

Long-term Ground Silica Loading Summary on M1T2

Flow, %	100%	Total
Flow, gpm	24	
Runs	46	46
Time/run	150	6900
Total Volume gallons	165,600	165,600
ft ³	22,139.04	22,139.04
acre-in	6.099	6.099
L	625,968	625,968
Concentration, mg/L	200	
Total Load mg	125,193,600	125,193,600
kg	125.19	125.19
lb	275.43	275.43
Load/Catchment Rainfall depth lb/acre-in	45.16	45.16

The area that M1T2 is estimated to treat is based on the appropriate design flow, 17 gpm, for the 2007 Perk Filter™ (OWP, 2007).

Area Treated by M1T2 and M1T2

$$Q = CIA \rightarrow A = Q / CI$$

			Conversions	
Flow, Q =	17	gpm	7.48	gal/ft ³
Runoff Coefficient, C =	0.9		12	in/ft
Rainfall Intensity, I =	0.2	in/hr	43560	sf/acre
			60	min/hr
Area, A =	0.21	Acres		

The rainfall that M1T2 is estimated to treat, 29.2 inches, is based on the parameters, Q, C, I, and A, estimated above and by obtaining the total volume of water by changing the rainfall depth through trial and error.

Rainfall Treated by M1T2 and M1T2

			Conversions	
Concentration =	200	mg/L	3.785	L/gal
Rainfall =	29.2	in	1,000,000	kg/mg
Total Volume =	165,600	Gal	2.2	lb/kg
Total Weight of Street Dust =	275.79	lb		

The amount of street dust used, created by OWP, is shown below. Samples with a concentration of 100 mg/L TSS were sent to Caltest to be tested for total phosphorus. A composite sample was created based on the street dust inventory.

Location	Inventory, kg	Percent per Sample	[TSS], mg/L	[TP], mg/L	[TP]/[TSS], g/g
Sacramento	6.3	19%	1000	0.65	0.0007
Placerville	10.5	32%	1000	0.96	0.0010
Pollock Pines	2	6%	1000	0.86	0.0009
South Lake Tahoe Sludge Ponds	4.3	13%	1000	0.78	0.0008
South Lake Tahoe - Caltrans	10	30%	1000	1.4	0.0014
Composite	33.1	100%	1000	0.87	0.00087

The volatile solids testing results on street dust are shown below. South Lake Tahoe has a higher vegetation content compared to Sacramento. The composite samples 1 and 2 are composites of the Sacramento, Placerville, and El Dorado County street sweepings.

Volatile Solids Testing on Street Dust

	Mass of Sediment	Mass of Boat	After Oven	Fixed Solids	After Furnace	% VS
Sweepings	g	g	g	g	g	g
Sacramento	0.0113	1.4266	1.4375	0.0109	1.4367	7%
S. Lake Tahoe	0.0121	1.4273	1.4386	0.0113	1.4373	12%
Composite	1.0662	1.3183	2.3805	1.0622	2.2732	10%
Composite (replicate)	1.0023	1.3288	2.3273	0.9985	2.2234	10%

Since the specific gravity of street dust is unknown, a test was performed to estimate the value. Below is a series of equations used to calculate the specific gravity of street dust and their values.

$$SpecificGravity_{SD} = \frac{\rho_{SD}}{\rho_{Water}}$$

$$\rho_{SD} = \frac{mass}{volume}$$

$$V_{StreetDust} = V_{Total} - V_{Water} - V_{sodiumhexametaphosphate}$$

- Total Volume = 50 ml
- Volume of Water = 33.75 ml
- Volume of Sodium Hexametaphosphate = 8 ml
- Volume of Street Dust = 8.25 ml
- Mass of Street Dust = 16.71 g
- $\rho_{SD} = 2.03$ g/ml
- $\rho_{Water} = 1$ g/ml
- $SG_{SD} = 2.03$**

A hydrometer test was performed on ground silica and street dust to compare the particle size distribution results with the Fluid Particle Image Analyzer particle size distribution results. Calculations for the hydrometer test are shown below.

$$\text{Composite Correction} = F_z + F_m + F_T$$

F_z = Reading from top of meniscus in a water mixed with dispersing agent solution

F_m = Meniscus correction ≈ 1

F_T = Temperature of a water mixed with dispersing agent solution

Percent Finer = Corrected Hydrometer Reading / Mass of Sediment

Effective Depth of the Hydrometer = $16.29 - 0.164 \cdot \text{Actual Hydrometer Reading}$

Diameter of the Soil Particles = K-Value \cdot Effective depth of the Hydrometer

K-Value is obtained from interpolating values in K-Value table.

Particle images of 500 mg/L of ground silica, 500 mg/L of street dust, and an approximately 100 mg/L sample of street dust from run 10 were compared, as shown in the Figure below.

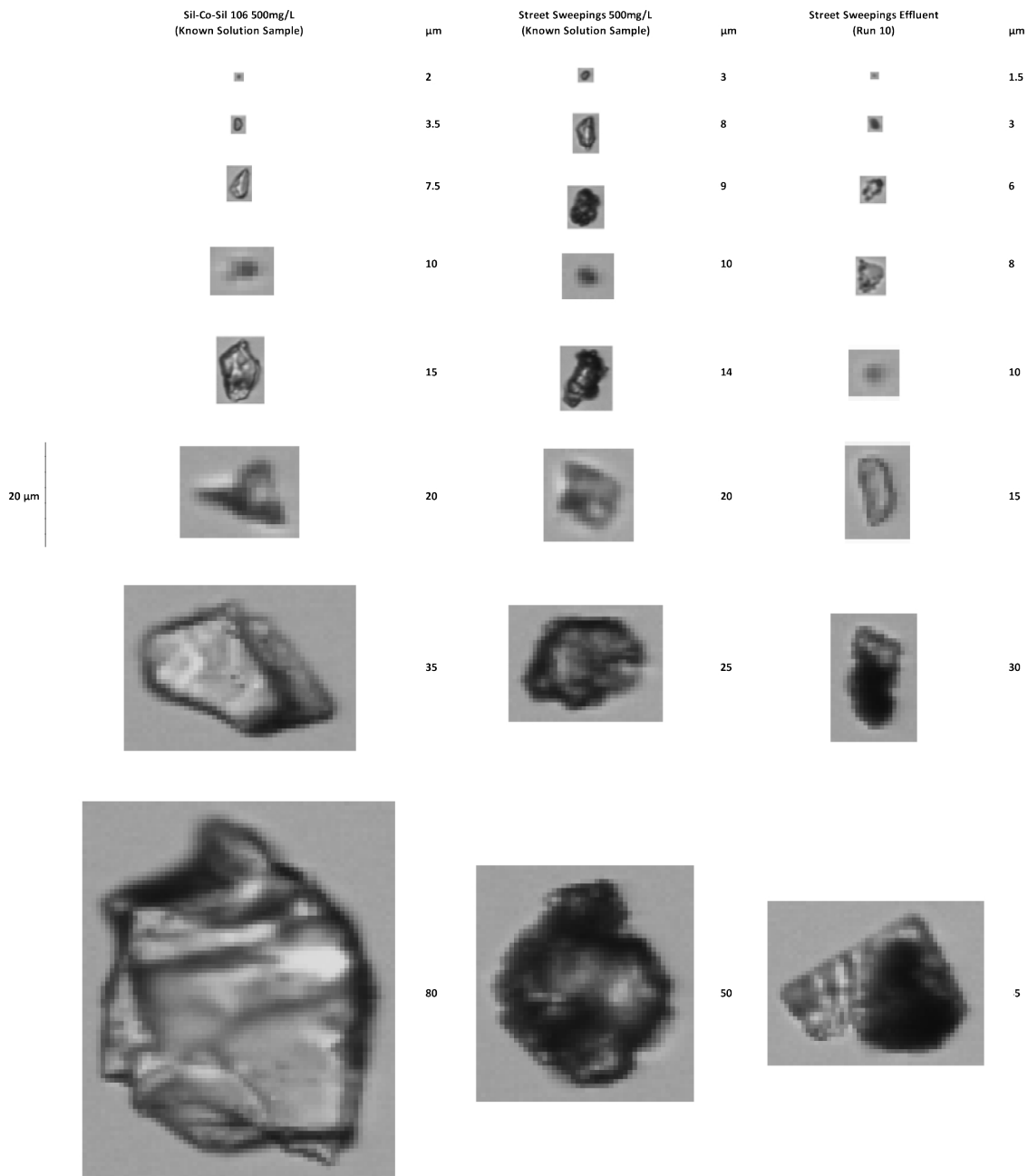

A mass balance was performed to confirm the removal results of the long-term ground silica test. Calculations are shown below.

Sample	V_{media} L	V_{void} L	Notes
Top Filter	35	16	* Smaller zeolite media (yellow)
Bottom Filter	35	18.7	
New Media	1	0.44	Void of New Media without ground silica

Sil-Co-Sil in Filters

$$V_{\text{SCS}} = V_{\text{media, top and bottom}} - V_{\text{void, new media}} \times V_{\text{media, top and bottom}} - V_{\text{void, top and bottom}} \quad m_{\text{SCS}} = \rho_{\text{SCS}} * V_{\text{SCS}}$$

$$V_{\text{SCS}} = 4.5 \text{ L}$$

$$\text{Density}_{\text{SCS}} = 2.65 \text{ kg/L}$$

$$m_{\text{SCS in filters}} = 11.93 \text{ kg}$$

Sil-Co-Sil in Tank

$$m_{\text{SCS settled in tank}} = 13.30 \text{ kg}$$

Total Sil-Co-Sil in Filters and Tank

$$m_{\text{SCS total}} = 25.23 \text{ kg}$$

Sil-Co-Sil used in Phase II

$$C_{\text{influent}} = 200 \text{ mg/L} \quad \text{Conversion} = 3.785 \text{ L/gal}$$

$$Q_{\text{main water supply}} = 24 \text{ gpm} \quad \text{Conversion} = 10^6 \text{ mg/kg}$$

$$t = 150 \text{ min/run}$$

$$\text{SCS / Run} = \frac{C \times 3.785 \text{ L / gal} \times Q \times t}{10^6 \text{ mg / kg}}$$

$$\text{SCS/Run} = 2.73 \text{ kg/run}$$

$$\text{Total \# of Runs} = 46$$

$$m_{\text{SCS used in Ph2}} = 125.36 \text{ kg}$$

Difference

23% = Removal efficiency based on TSS and SSC performance results

$$\text{Percent Removal}_{\text{massbalance}} = \frac{m_{\text{SCS, filter and tank}}}{m_{\text{SCS / Run}}} \times 100\%$$

20% = Removal efficiency based on mass balance

13% = Percent Difference

The F-Ratio equations are shown below.

$$F - \text{Ratio} = \frac{SSE_{\text{lackoffit}}}{SSE_{\text{pure}}}$$

$$SSE_{\text{lackoffit}} = SSE - SSE_{\text{pure}}$$

$$SSE = \Sigma(y - y')^2$$

$$SSE_{\text{pure}} = \Sigma\sigma^2(n_i - 1)$$

APPENDIX B: Laboratory Reports (available on CD)